

e-trim™ 20MHz, High Precision CMOS Operational Amplifier

FEATURES

- **OFFSET:** 15 μ V (typ), 150 μ V (max)
- **DRIFT:** 0.3 μ V/ $^{\circ}$ C (typ), 1.5 μ V/ $^{\circ}$ C (max)
- **BANDWIDTH:** 20MHz
- **SLEW RATE:** 30V/ μ s
- **BIAS CURRENT:** 100pA (max)
- **LOW NOISE:** 6nV/ $\sqrt{\text{Hz}}$ at 100kHz
- **THD+N:** 0.0003% at 1kHz
- **QUIESCENT CURRENT:** 4.3mA/ch
- **SUPPLY VOLTAGE:** 4V to 12V
- **SHUTDOWN MODE (OPA728):** 6 μ A

APPLICATIONS

- OPTICAL NETWORKING
- TRANSIMPEDANCE AMPLIFIERS
- INTEGRATORS
- ACTIVE FILTERS
- A/D CONVERTER DRIVERS
- I/V CONVERTER FOR DACs
- HIGH PERFORMANCE AUDIO
- PROCESS CONTROL
- TEST EQUIPMENT

OPAx727 AND OPAx728 RELATED PRODUCTS

| FEATURES | PRODUCT |
|---|---------|
| 20MHz, 3mV, 4 μ V/ $^{\circ}$ C (non-e-trim version of OPA727) | OPA725 |
| 20MHz, 3mV, 4 μ V/ $^{\circ}$ C, Shutdown (non-e-trim version of OPA728) | OPA726 |

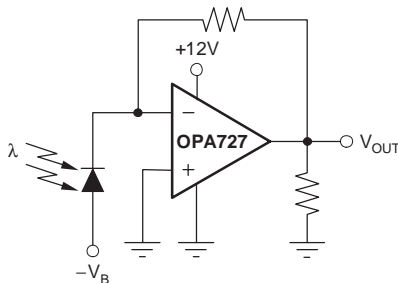

DESCRIPTION

The OPA727 and OPA728 series op amps use a state-of-the-art 12V analog CMOS process and e-trim, a package-level trim, offering outstanding dc precision and ac performance. The extremely low offset (150 μ V max) and drift (1.5 μ V/ $^{\circ}$ C) are achieved by trimming the IC digitally after packaging to avoid the shift in parameters as a result of stresses during package assembly. To correct for offset drift, the OPA727/OPA728 family is trimmed over temperature. The devices feature very high CMRR and open loop gain to minimize errors.

Excellent ac characteristics, such as 20MHz GBW, 30V/ μ s slew rate and 0.0003% THD+N make the OPA727 and OPA728 well-suited for communication, high-end audio, and active filter applications. With a bias current of less than 100pA, they are ideal for use as transimpedance (I/V-conversion) amplifiers for monitoring optical power in ONET applications.

Optimized for single-supply operation up to 12V, the input common-mode range extends to GND for true single-supply functionality. The output swings to within 150mV of the rails, maximizing dynamic range. The low quiescent current of 4.3mA makes it well-suited for use in battery-operated equipment. The OPA728 shutdown version reduces the quiescent current to typically 6 μ A and features a reference pin for easy shutdown operation with standard CMOS logic in dual-supply applications.

For ease of use, the OPA727 and OPA728 op amp families are fully specified and tested over the supply range of 4V to 12V. The OPA727 (single) and OPA728 (single with shutdown) are available in MSOP-8 and DFN-8; the OPA2727 (dual) is available in DFN-8 and SO-8, and the quad version OPA4727 will be available Q1'05 in TSSOP-14. All versions are specified for operation from -40° C to $+125^{\circ}$ C.



Please be aware that an important notice concerning availability, standard warranty, and use in critical applications of Texas Instruments semiconductor products and disclaimers thereto appears at the end of this data sheet.

e-trim™ is a trademark of Texas Instruments, Incorporated. All other trademarks are the property of their respective owners.

PACKAGE/ORDERING INFORMATION(1)

| PRODUCT | PACKAGE-LEAD | PACKAGE DESIGNATOR | PACKAGE MARKING |
|---------------------|--------------|--------------------|-----------------|
| Non-Shutdown | | | |
| OPA727 | MSOP-8 | DGK | AUE |
| | DFN-8 | DRB | NSF |
| OPA2727 | DFN-8(2) | DRB | NSD |
| OPA2727 | SO-8 | D | OPA2727A |
| OPA4727(2) | TSSOP-14 | PW | OPA4727A |
| Shutdown | | | |
| OPA728 | MSOP-8 | DGK | AUF |
| | DFN-8 | DRB | NSG |

(1) For the most current package and ordering information, see the Package Option Addendum located at the end of this datasheet.

(2) Available Q1'05.

ABSOLUTE MAXIMUM RATINGS(1)

| | |
|------------------------------------|----------------------|
| Supply Voltage | +13.2V |
| Signal Input Terminals, Voltage(2) | -0.5V to (V+) + 0.5V |
| Current(2) | ±10mA |
| Output Short Circuit(3) | Continuous |
| Operating Temperature | -55°C to +125°C |
| Storage Temperature | -55°C to +150°C |
| Junction Temperature | +150°C |
| Lead Temperature (soldering, 10s) | +300°C |
| ESD Rating (Human Body Model) | 2000V |
| (Charged Device Model) | 1000V |

(1) Stresses above these ratings may cause permanent damage. Exposure to absolute maximum conditions for extended periods may degrade device reliability. These are stress ratings only, and functional operation of the device at these or any other conditions beyond those specified is not supported.

(2) Input terminals are diode-clamped to the power-supply rails. Input signals that can swing more than 0.5V beyond the supply rails should be current limited to 10mA or less.

(3) Short-circuit to ground, one amplifier per package.



This integrated circuit can be damaged by ESD. Texas Instruments recommends that all integrated circuits be handled with appropriate precautions. Failure to observe proper handling and installation procedures can cause damage.

ESD damage can range from subtle performance degradation to complete device failure. Precision integrated circuits may be more susceptible to damage because very small parametric changes could cause the device not to meet its published specifications.

PIN CONFIGURATIONS

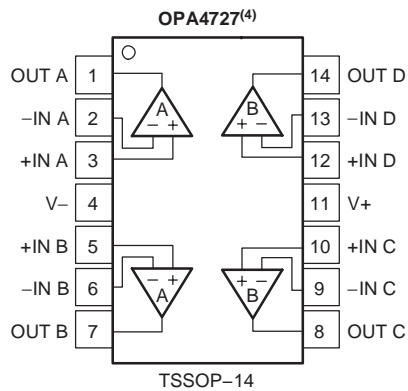
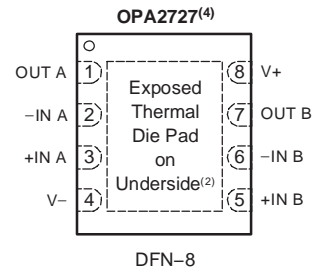
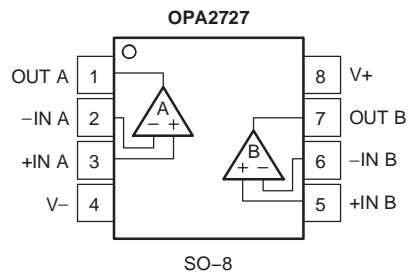
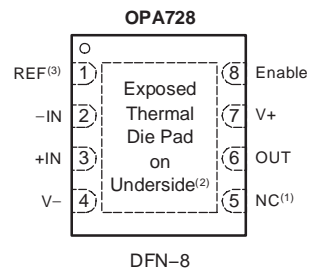
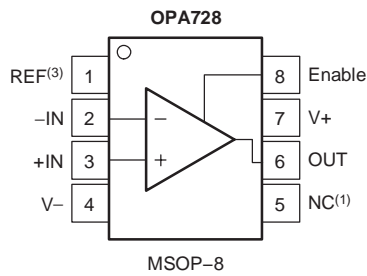
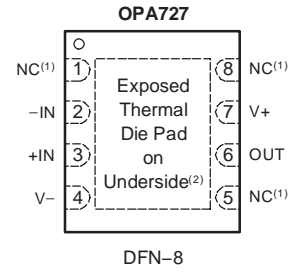
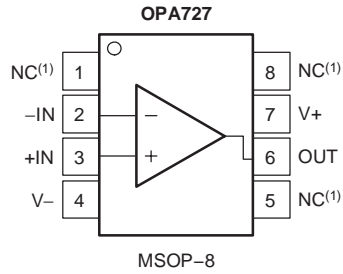

- (1) NC denotes no internal connection.
- (2) Connect thermal die pad to V-.
- (3) REF is the reference voltage for ENABLE pin.
- (4) Available Q1'05.

ELECTRICAL CHARACTERISTICS: $V_S = +4V$ to $+12V$ or $V_S = \pm 2V$ to $\pm 6V$

Boldface limits apply over the specified temperature range, $T_A = -40^\circ\text{C}$ to $+125^\circ\text{C}$.

At $T_A = +25^\circ\text{C}$, $R_L = 10\text{k}\Omega$ connected to $V_S/2$, and $V_{OUT} = V_S/2$, unless otherwise noted.

| PARAMETER | CONDITIONS | OPA727, OPA728, OPA727Z | | | UNIT |
|--|--------------|---|-----------------------------|------------|------------------------------|
| | | MIN | TYP | MAX | |
| OFFSET VOLTAGE | | | | | |
| Input Offset Voltage | V_{OS} | $V_S = \pm 5V, V_{CM} = 0V$ | 15 | 150 | μV |
| Drift | dV_{OS}/dT | 0°C to $+85^\circ\text{C}$ | 0.3 | 1.5 | $\mu\text{V}/^\circ\text{C}$ |
| | | -40°C to $+125^\circ\text{C}$ | 0.6 | 3.0 | $\mu\text{V}/^\circ\text{C}$ |
| vs Power Supply | PSRR | $V_S = \pm 2V$ to $\pm 6V, V_{CM} = V-$ | 30 | 150 | $\mu\text{V}/V$ |
| Over Temperature | | $V_S = \pm 2V$ to $\pm 6V, V_{CM} = V-$ | | 150 | $\mu\text{V}/V$ |
| Channel Separation, dc | | | 1 | | $\mu\text{V}/V$ |
| INPUT BIAS CURRENT | | | | | |
| Input Bias Current, OPA727, OPA728 | I_B | | ± 10 | ± 100 | pA |
| Input Bias Current, OPA727Z | | | ± 60 | ± 500 | pA |
| Over Temperature | | | See Typical Characteristics | | |
| Input Offset Current | I_{OS} | | ± 10 | ± 100 | pA |
| NOISE | | | | | |
| Input Voltage Noise, $f = 0.1\text{Hz}$ to 10Hz | e_n | $V_S = \pm 6V, V_{CM} = 0V$ | 10 | | μV_{PP} |
| Input Voltage Noise Density, $f = 10\text{kHz}$ | e_n | $V_S = \pm 6V, V_{CM} = 0V$ | 10 | | $\text{nV}/\sqrt{\text{Hz}}$ |
| Input Voltage Noise Density, $f = 100\text{kHz}$ | e_n | $V_S = \pm 6V, V_{CM} = 0V$ | 6 | | $\text{nV}/\sqrt{\text{Hz}}$ |
| Input Current Noise Density, $f = 1\text{kHz}$ | i_n | $V_S = \pm 6V, V_{CM} = 0V$ | 2.5 | | $\text{fA}/\sqrt{\text{Hz}}$ |
| INPUT VOLTAGE RANGE | | | | | |
| Common-Mode Voltage Range | V_{CM} | | (V-) | | V |
| Common-Mode Rejection Ratio | CMRR | $(V-) \leq V_{CM} \leq (V+) - 2.5V$ | 86 | 94 | dB |
| Over Temperature | | $(V-) \leq V_{CM} \leq (V+) - 2.5V$ | 84 | | dB |
| | | $(V-) \leq V_{CM} \leq (V+) - 3V$ | 94 | 100 | dB |
| Over Temperature | | $(V-) \leq V_{CM} \leq (V+) - 3V$ | 84 | | dB |
| INPUT IMPEDANCE | | | | | |
| Differential | | | $10^{11} \parallel 5$ | | $\Omega \parallel \text{pF}$ |
| Common-Mode | | | $10^{11} \parallel 4$ | | $\Omega \parallel \text{pF}$ |
| OPEN-LOOP GAIN | | | | | |
| Open-Loop Voltage Gain | A_{OL} | | | | dB |
| OPA727, OPA728 | | $R_L = 100\text{k}\Omega, 0.15V < V_O < (V+) - 0.15V$ | 110 | 120 | dB |
| Over Temperature | | $R_L = 100\text{k}\Omega, 0.15V < V_O < (V+) - 0.15V$ | 100 | | dB |
| OPA727Z | | $R_L = 100\text{k}\Omega, 0.175V < V_O < (V+) - 0.175V$ | 110 | 120 | dB |
| Over Temperature | | $R_L = 100\text{k}\Omega, 0.175V < V_O < (V+) - 0.175V$ | 100 | | dB |
| OPA727, OPA728 | | $R_L = 1\text{k}\Omega, 0.25V < V_O < (V+) - 0.25V$ | 106 | 116 | dB |
| Over Temperature | | $R_L = 1\text{k}\Omega, 0.25V < V_O < (V+) - 0.25V$ | 96 | | dB |
| OPA727Z | | $R_L = 2\text{k}\Omega, 0.25V < V_O < (V+) - 0.25V$ | 106 | 116 | dB |
| Over Temperature | | $R_L = 2\text{k}\Omega, 0.5V < V_O < (V+) - 0.5V$ | 96 | | dB |
| FREQUENCY RESPONSE | | | | | |
| Gain-Bandwidth Product | GBW | $C_L = 20\text{pF}$ | | 20 | MHz |
| Slew Rate | SR | $G = +1$ | | 30 | $\text{V}/\mu\text{s}$ |
| Settling Time, 0.1% | t_S | $V_S = \pm 6V, 5V$ Step, $G = +1$ | | 350 | ns |
| 0.01% | | $V_S = \pm 6V, 5V$ Step, $G = +1$ | | 450 | ns |
| Overload Recovery Time | | $V_{IN} \cdot \text{Gain} > V_S$ | | 50 | ns |
| Total Harmonic Distortion + Noise | THD+N | $V_S = \pm 6V, V_{OUT} = 2V_{RMS}, R_L = 600\Omega, G = +1, f = 1\text{kHz}$ | | 0.0003 | % |

ELECTRICAL CHARACTERISTICS: $V_S = +4V$ to $+12V$ or $V_S = \pm 2V$ to $\pm 6V$ (continued)
Boldface limits apply over the specified temperature range, $T_A = -40^\circ\text{C}$ to $+125^\circ\text{C}$.

 At $T_A = +25^\circ\text{C}$, $R_L = 10\text{k}\Omega$ connected to $V_S/2$, and $V_{OUT} = V_S/2$, unless otherwise noted.

| PARAMETER | CONDITIONS | OPA727, OPA728, OPA2727 | | | UNIT |
|--|--|-----------------------------|-------------|---------------------|--------------------|
| | | MIN | TYP | MAX | |
| OUTPUT | | | | | |
| Voltage Output Swing from Rail OPA727, OPA728 | $R_L = 100\text{k}\Omega$, $A_{OL} > 110\text{dB}$ | | 100 | 150 | mV |
| Over Temperature | $R_L = 100\text{k}\Omega$, $A_{OL} > 100\text{dB}$ | | | 150 | mV |
| OPA2727 | $R_L = 100\text{k}\Omega$, $A_{OL} > 110\text{dB}$ | | 125 | 175 | mV |
| Over Temperature | $R_L = 100\text{k}\Omega$, $A_{OL} > 100\text{dB}$ | | | 175 | mV |
| OPA727, OPA728 | $R_L = 1\text{k}\Omega$, $A_{OL} > 106\text{dB}$ | | 200 | 250 | mV |
| Over Temperature | $R_L = 1\text{k}\Omega$, $A_{OL} > 96\text{dB}$ | | | 250 | mV |
| OPA2727 | $R_L = 2\text{k}\Omega$, $A_{OL} = 106\text{dB}$ | | 200 | 250 | mV |
| Over Temperature | $R_L = 2\text{k}\Omega$, $A_{OL} = 96\text{dB}$ | | | 500 | mV |
| Output Current I_{OUT} | $ V_S - V_{OUT} < 1V$ | | 40 | | mA |
| Short-Circuit Current I_{SC} | | | ± 55 | | mA |
| Capacitive Load Drive C_{LOAD} | | See Typical Characteristics | | | |
| Open-Loop Output Impedance | $f = 1\text{MHz}$, $I_O = 0$ | | 40 | | Ω |
| ENABLE/SHUTDOWN (OPA728) | | | | | |
| t_{OFF} | | | 5 | | μs |
| t_{ON} | | | 80 | | μs |
| Enable Reference (Ref Pin) Voltage Range | | V_- | | $(V_+) - 2$ | V |
| V_L (amplifier is disabled) | | | | $< V_{DGND} + 0.8V$ | V |
| V_H (amplifier is enabled) | | $> V_{DGND} + 2V$ | | | V |
| Input Bias Current of Enable Pin | | | 5 | | pA |
| I_{QSD} | Amplifier Disabled | | 6 | 15 | μA |
| POWER SUPPLY | | | | | |
| Specified Voltage Range V_S | | 4 | | 12 | V |
| Operating Voltage Range V_S | | | 3.5 to 13.2 | | V |
| Quiescent Current (per amplifier) I_Q | $I_O = 0$ | | 4.3 | 6.5 | mA |
| Over Temperature | | | | 6.5 | mA |
| TEMPERATURE RANGE | | | | | |
| Specified Range | | -40 | | +125 | $^\circ\text{C}$ |
| Operating Range | | -55 | | +125 | $^\circ\text{C}$ |
| Storage Range | | -55 | | +150 | $^\circ\text{C}$ |
| Thermal Resistance θ_{JA} | | | | | |
| MSOP-8, SO-8 | | | 150 | | $^\circ\text{C/W}$ |
| TSSOP-14 | | | 100 | | $^\circ\text{C/W}$ |
| DFN-8 | | | 46 | | $^\circ\text{C/W}$ |

TYPICAL CHARACTERISTICS

At $T_A = +25^\circ\text{C}$, $V_S = \pm 6\text{V}$, $R_L = 10\text{k}\Omega$ connected to $V_S/2$, and $V_{OUT} = V_S/2$, unless otherwise noted.

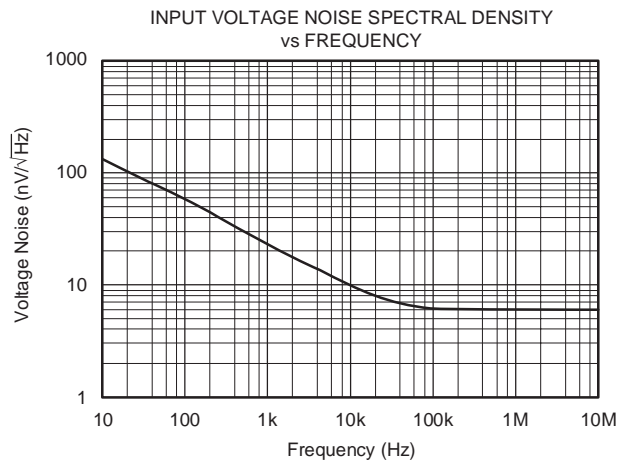
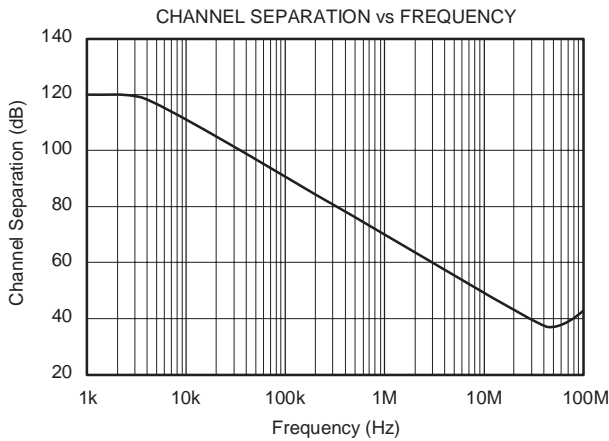
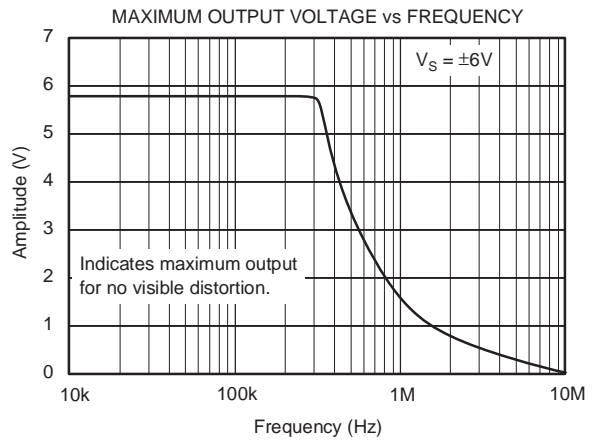
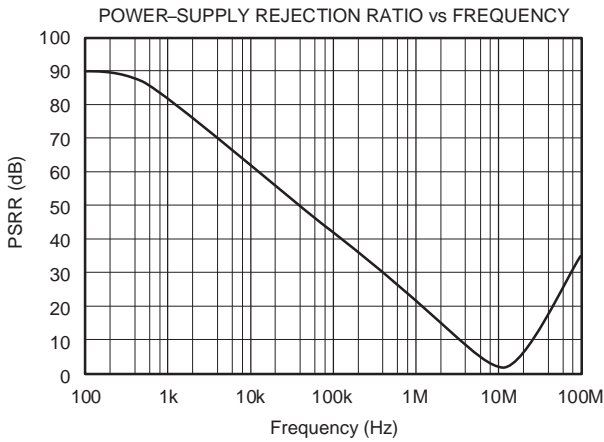
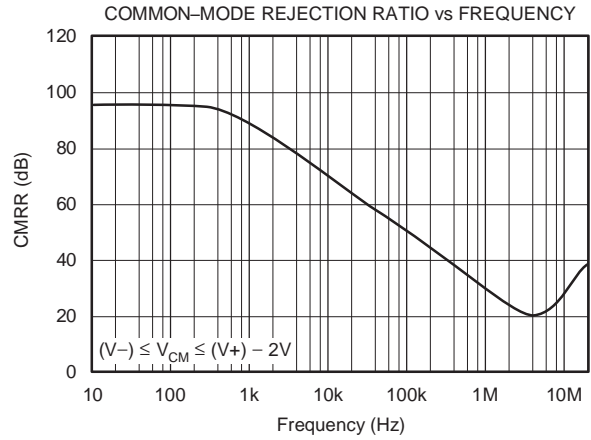
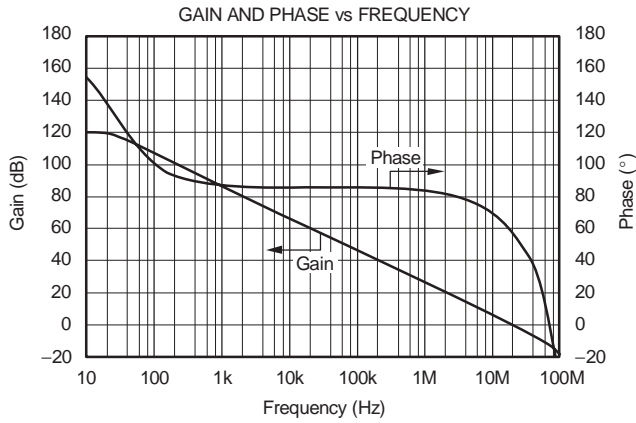

TYPICAL CHARACTERISTICS (continued)

At $T_A = +25^\circ\text{C}$, $V_S = \pm 6\text{V}$, $R_L = 10\text{k}\Omega$ connected to $V_S/2$, and $V_{OUT} = V_S/2$, unless otherwise noted.

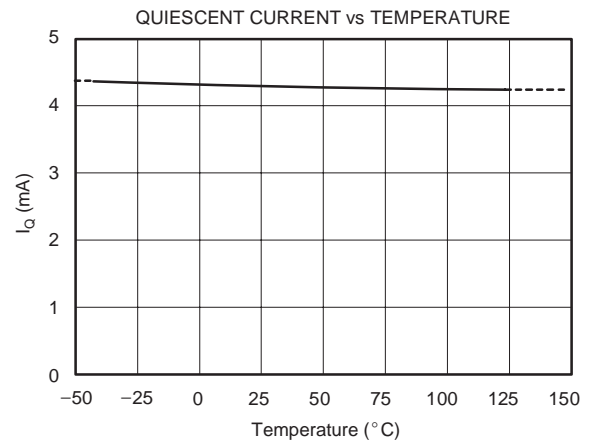
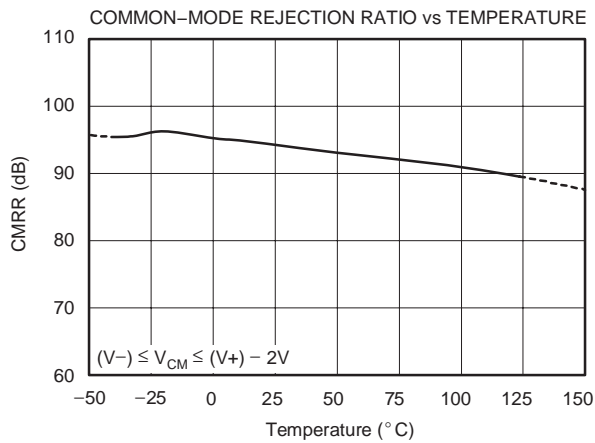
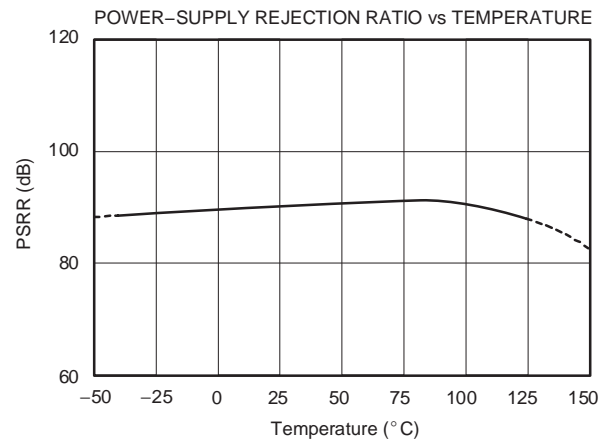
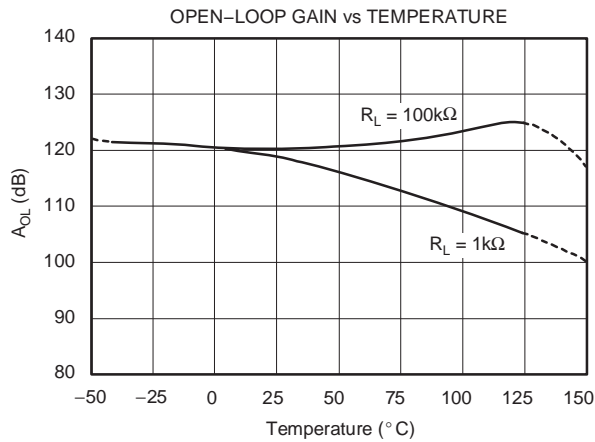
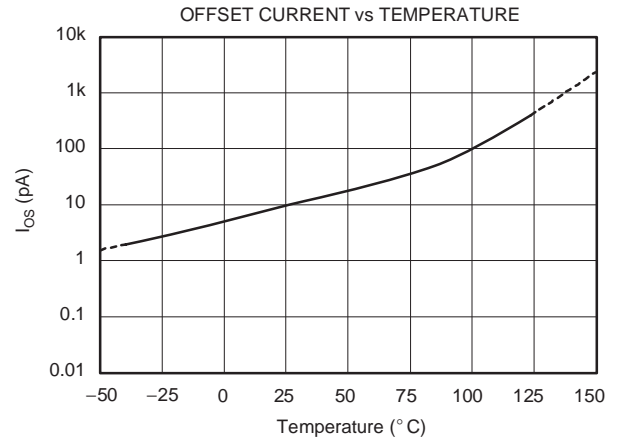
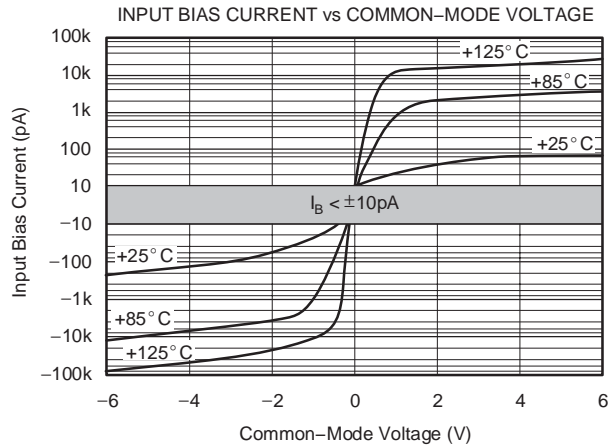

TYPICAL CHARACTERISTICS (continued)

At $T_A = +25^\circ\text{C}$, $V_S = \pm 6\text{V}$, $R_L = 10\text{k}\Omega$ connected to $V_S/2$, and $V_{OUT} = V_S/2$, unless otherwise noted.

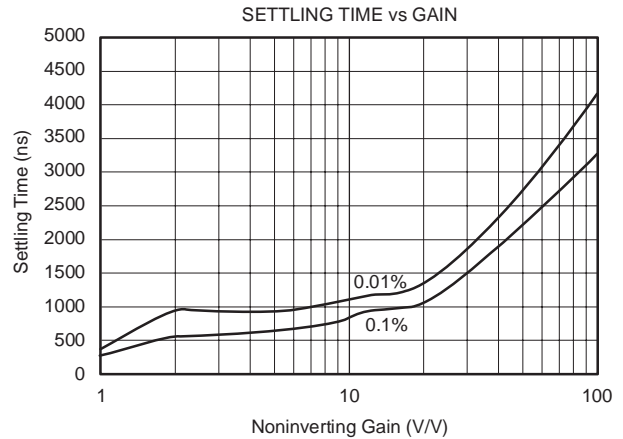
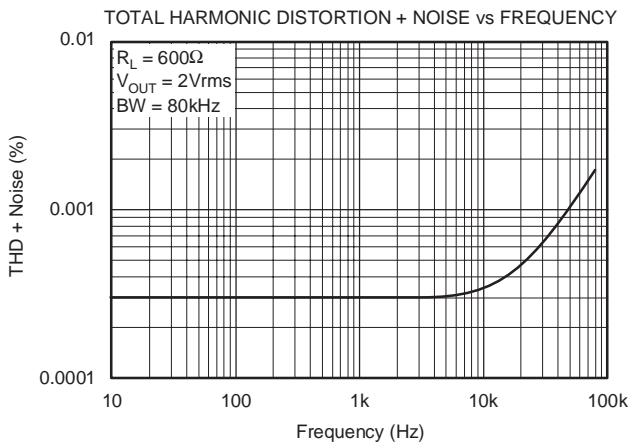
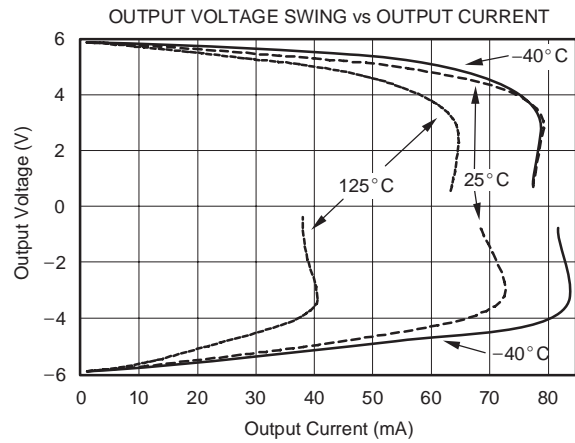
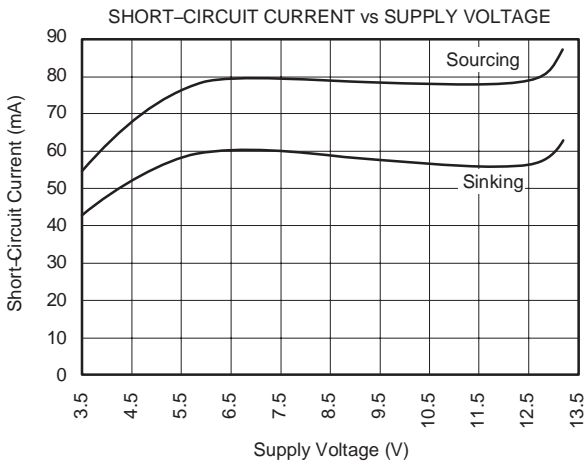
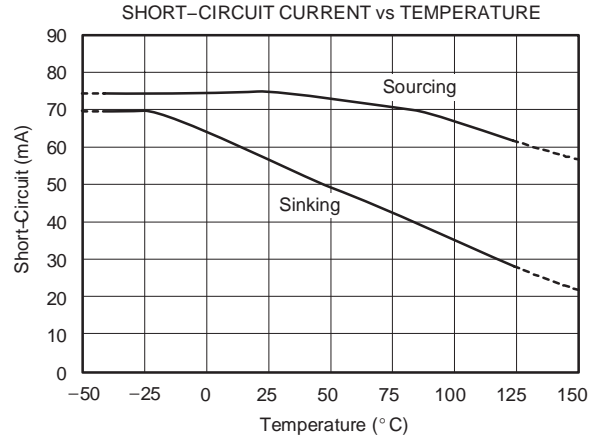
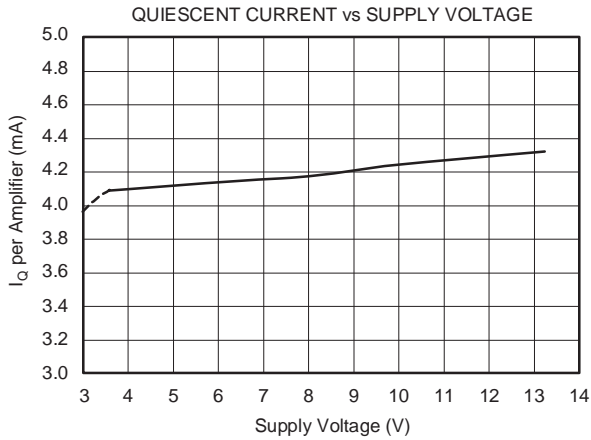

TYPICAL CHARACTERISTICS (continued)

At $T_A = +25^\circ\text{C}$, $V_S = \pm 6\text{V}$, $R_L = 10\text{k}\Omega$ connected to $V_S/2$, and $V_{OUT} = V_S/2$, unless otherwise noted.

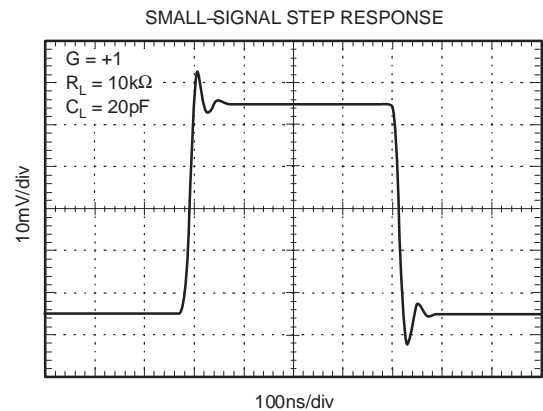
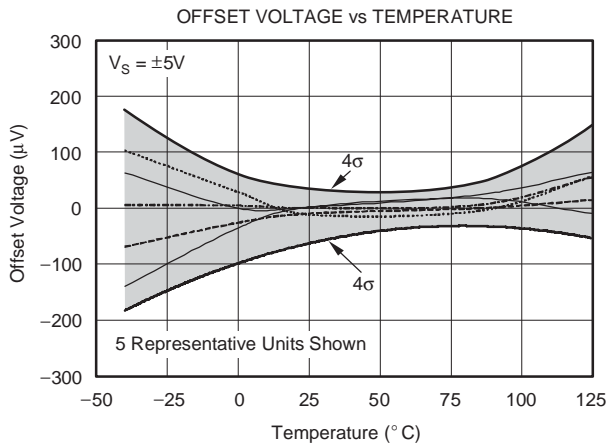
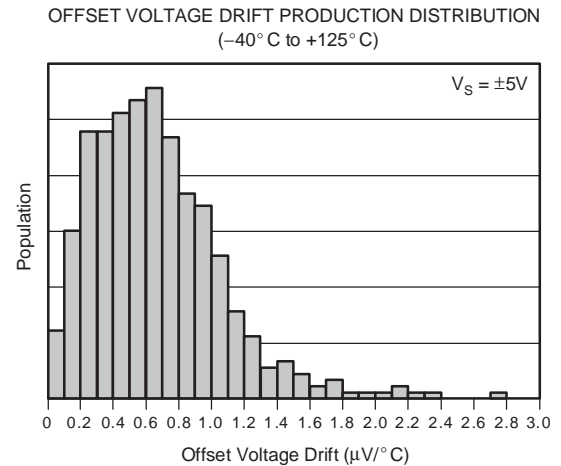
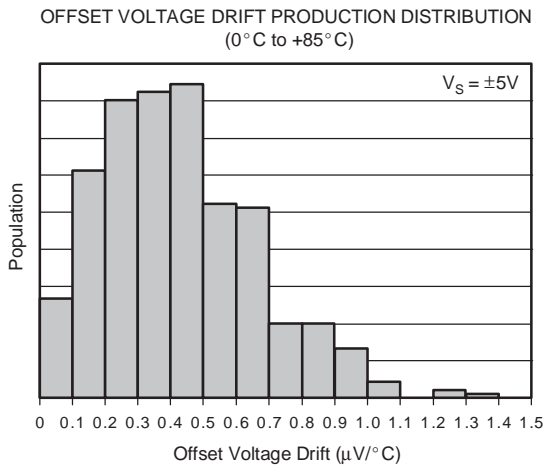
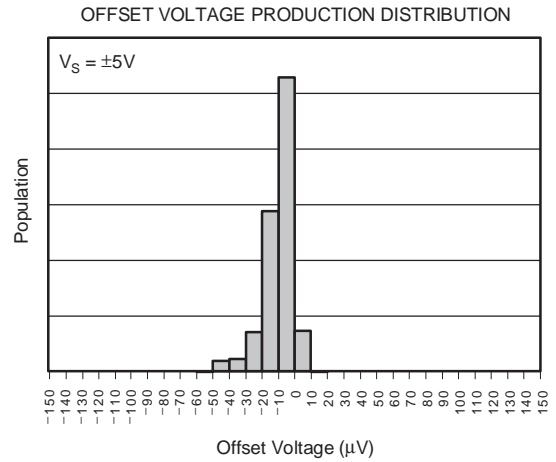
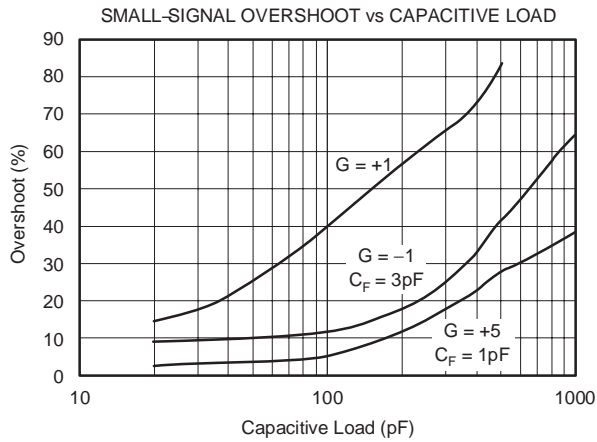

TYPICAL CHARACTERISTICS (continued)

At $T_A = +25^\circ\text{C}$, $V_S = \pm 6\text{V}$, $R_L = 10\text{k}\Omega$ connected to $V_S/2$, and $V_{OUT} = V_S/2$, unless otherwise noted.

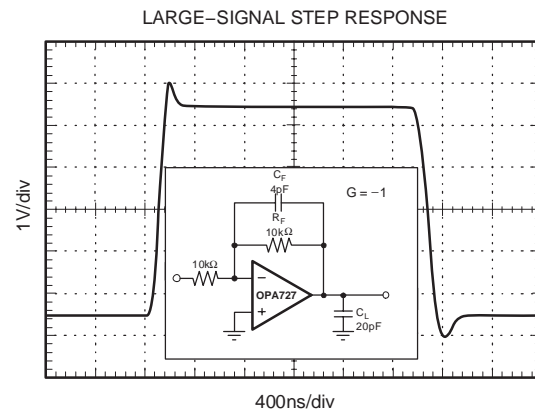
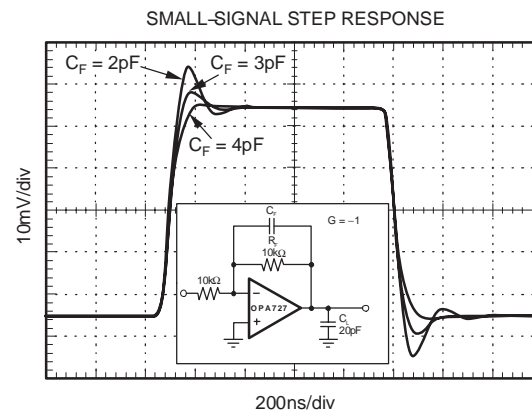
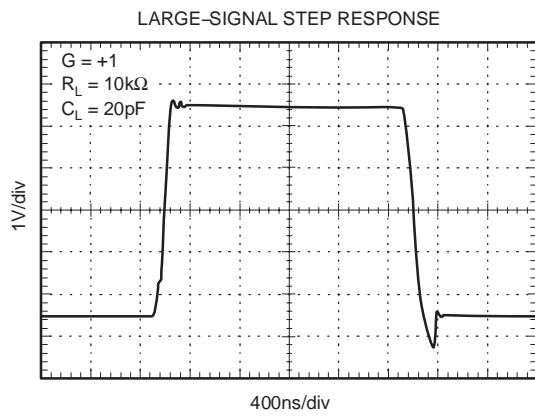

APPLICATIONS INFORMATION

The OPA727 and OPA728 family of op amps use *e-trim*[™], an adjustment to offset voltage and temperature drift made during the final steps of manufacturing after the plastic molding is completed. This compensates for performance shifts that can occur during the molding process. Through *e-trim*, the OPA727 and OPA728 deliver excellent offset voltage (150 μ V max) and extremely low offset voltage drift (1.5 μ V/ $^{\circ}$ C). Additionally, these 20MHz CMOS op amps have a fast slew rate, low noise, and excellent PSRR, CMRR, and A_{OL} . They can operate on typically 4.3mA quiescent current from a single (or split) supply in the range of 4V to 12V (\pm 2V to \pm 6V), making them highly versatile and easy to use. They are stable in a unity-gain configuration.

Power-supply pins should be bypassed with 1nF ceramic capacitors in parallel with 1 μ F tantalum capacitors.

OPERATING VOLTAGE

OPA727 series op amps are specified from 4V to 12V supplies over a temperature range of -40° C to $+125^{\circ}$ C. They will operate well in \pm 5V or +5V to +12V power-supply systems. Parameters that vary significantly with operating voltage or temperature are shown in the Typical Characteristics.

ENABLE/SHUTDOWN

OPA727 series op amps require approximately 4.3mA quiescent current. The enable/shutdown feature of the OPA728 allows the op amp to be shut off to reduce this current to approximately 6 μ A.

The enable/shutdown input is referenced to the Enable Reference Pin, DGND (see *Pin Configurations*). This pin can be connected to logic ground in dual-supply op amp configurations to avoid level-shifting the enable logic signal, as shown in Figure 1.

The Enable Reference Pin voltage, V_{DGND} , must not exceed $(V+) - 2V$. It may be set as low as $V-$. The amplifier is enabled when the Enable Pin voltage is greater than $V_{DGND} + 2V$. The amplifier is disabled (shutdown) if the Enable Pin voltage is less than $V_{DGND} + 0.8V$. The Enable Pin is connected to internal pull-up circuitry and will enable the device if left unconnected.

COMMON-MODE VOLTAGE RANGE

The input common-mode voltage range of the OPA727 and OPA728 series extends from $V-$ to $(V+) - 2.5V$.

Common-mode rejection is excellent throughout the input voltage range from $V-$ to $(V+) - 3V$. CMRR decreases somewhat as the common-mode voltage extends to $(V+) - 2.5V$, but remains very good and is tested throughout this range. See the *Electrical Characteristics* table for details.

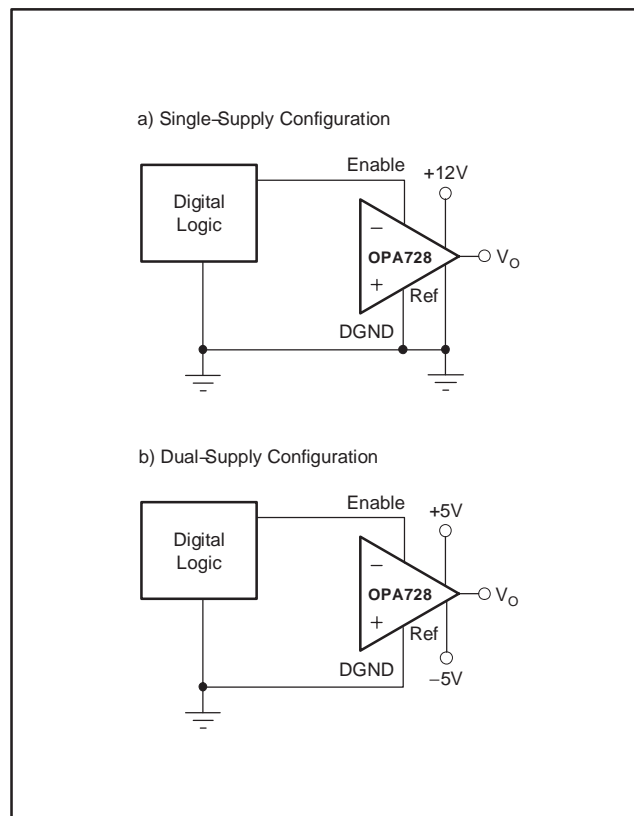

Figure 1. Enable Reference Pin Connection for Single- and Dual-Supply Configurations

INPUT OVER-VOLTAGE PROTECTION

Device inputs are protected by ESD diodes that will conduct if the input voltages exceed the power supplies by more than approximately 300mV. Momentary voltages greater than 300mV beyond the power supply can be tolerated if the current is limited to 10mA. This is easily accomplished with an input resistor in series with the op amp, as shown in Figure 2. The OPA727 series features no phase inversion when the inputs extend beyond supplies, if the input is current limited.

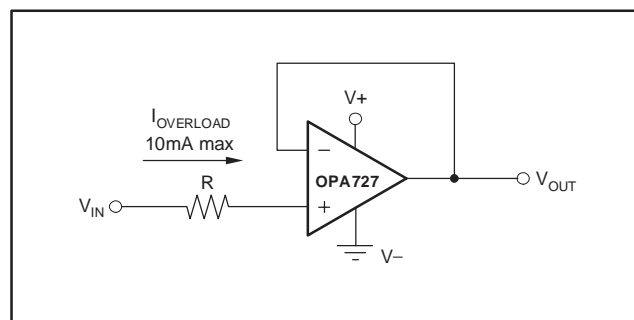

Figure 2. Input Current Protection for Voltages Exceeding the Supply Voltage

RAIL-TO-RAIL OUTPUT

A class AB output stage with common-source transistors is used to achieve rail-to-rail output. This output stage is capable of driving heavy loads connected to any point between $V+$ and $V-$. For light resistive loads ($> 100k\Omega$), the output voltage can swing to 150mV from the supply rail, while still maintaining excellent linearity ($A_{OL} > 110dB$). With 1k Ω resistive loads, the output is specified to swing to within 250mV from the supply rails with excellent linearity (see the Typical Characteristics curve, *Output Voltage Swing vs Output Current*).

CAPACITIVE LOAD AND STABILITY

Capacitive load drive is dependent upon gain and the overshoot requirements of the application. Increasing the gain enhances the ability of the amplifier to drive greater capacitive loads (see the Typical Characteristics curve, *Small-Signal Overshoot vs Capacitive Load*).

One method of improving capacitive load drive in the unity-gain configuration is to insert a 10 Ω to 20 Ω resistor inside the feedback loop, as shown in Figure 3. This reduces ringing with large capacitive loads while maintaining DC accuracy.

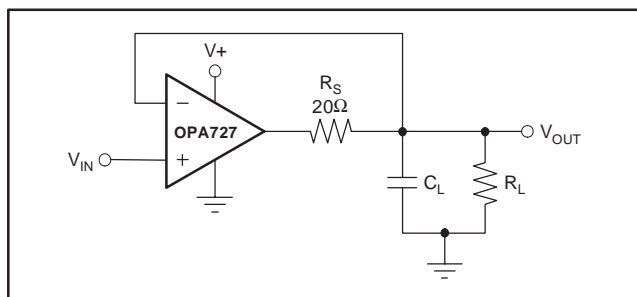

Figure 3. Series Resistor in Unity-Gain Buffer Configuration Improves Capacitive Load Drive

DRIVING FAST 16-BIT ADCs

The OPA727 series is optimized for driving fast 16-bit ADCs such as the ADS8342. The OPA727 op amps buffer the converter input capacitance and resulting charge injection, while providing signal gain. Figure 4 shows the OPA727 in a single-ended method of interfacing to the ADS8342 16-bit, 250kSPS, 4-channel ADC with an input range of $\pm 2.5V$. The OPA727 has demonstrated excellent settling time to the 16-bit level within the 600ns acquisition time of the ADS8342. The RC filter, shown in Figure 4, has been carefully tuned for best noise and settling performance. It may need to be adjusted for different op amp configurations. Please refer to the ADS8342 data sheet (available for download at www.ti.com) for additional information on this product.

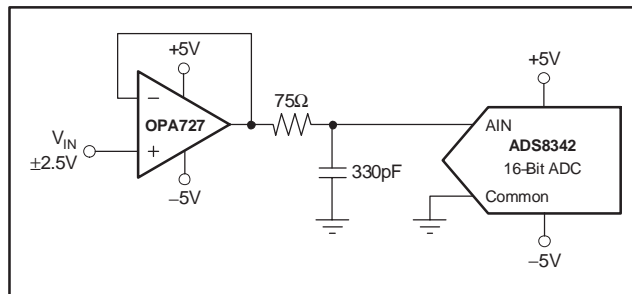

Figure 4. OPA727 Driving an ADC

TRANSIMPEDANCE AMPLIFIER

Wide bandwidth, low input bias current, and low input voltage and current noise make the OPA727 an ideal wideband photodiode transimpedance amplifier. Low-voltage noise is important because photodiode capacitance causes the effective noise gain of the circuit to increase at high frequency.

The key elements to a transimpedance design, as shown in Figure 5, are the expected diode capacitance (C_D), which should include the parasitic input common-mode and differential-mode input capacitance (4pF + 5pF for the OPA727); the desired transimpedance gain (R_F); and the GBW for the OPA727 (20MHz). With these three variables set, the feedback capacitor value (C_F) can be set to control the frequency response. C_F includes the stray capacitance of R_F , which is 0.2pF for a typical surface-mount resistor.

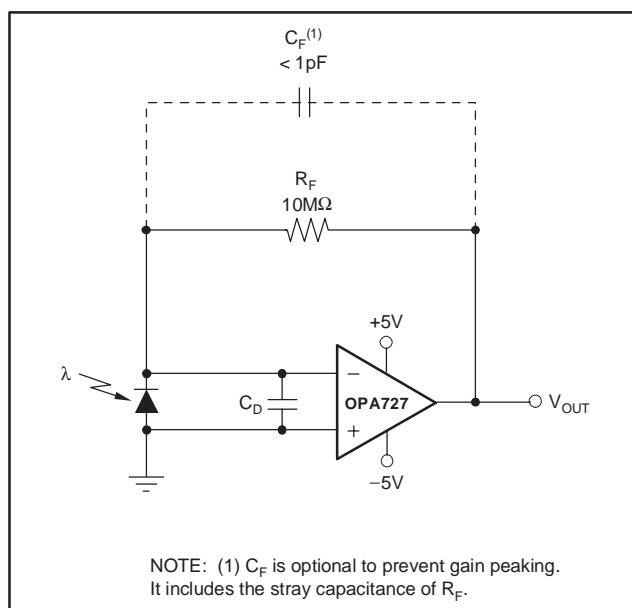

Figure 5. Dual-Supply Transimpedance Amplifier

To achieve a maximally-flat, 2nd-order Butterworth frequency response, the feedback pole should be set to:

$$\frac{1}{2\pi R_F C_F} = \sqrt{\frac{GBW}{4\pi R_F C_D}} \quad (1)$$

Bandwidth is calculated by:

$$f_{-3dB} = \sqrt{\frac{GBW}{2\pi R_F C_D}} \text{ Hz} \quad (2)$$

For even higher transimpedance bandwidth, the high-speed CMOS OPA380 (90MHz GBW), OPA354 (100MHz GBW), OPA300 (180 MHz GBW), OPA355 (200MHz GBW), or OPA656, OPA657 (400MHz GBW) may be used.

For single-supply applications, the +IN input can be biased with a positive dc voltage to allow the output to reach true zero when the photodiode is not exposed to any light, and respond without the added delay that results from coming out of the negative rail. (Refer to Figure 6.) This bias voltage also appears across the photodiode, providing a reverse bias for faster operation.

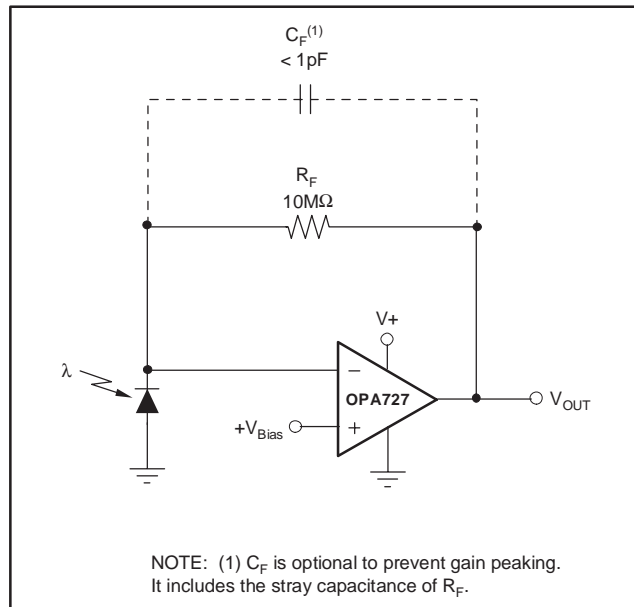

Figure 6. Single-Supply Transimpedance Amplifier

For additional information, refer to Application Bulletin SBOA055, *Compensate Transimpedance Amplifiers Intuitively*, available for download at www.ti.com.

OPTIMIZING THE TRANSIMPEDANCE CIRCUIT

To achieve the best performance, components should be selected according to the following guidelines:

1. For lowest noise, select R_F to create the total required gain. Using a lower value for R_F and adding gain after the transimpedance amplifier generally produces poorer noise performance. The noise produced by R_F increases with the square-root of R_F , whereas the signal increases linearly. Therefore, signal-to-noise ratio is improved when all the required gain is placed in the transimpedance stage.
2. Minimize photodiode capacitance and stray capacitance at the summing junction (inverting input). This capacitance causes the voltage noise of the op amp to be amplified (increasing amplification at high frequency). Using a low-noise voltage source to reverse-bias a photodiode can significantly reduce its capacitance. Smaller photodiodes have lower capacitance. Use optics to concentrate light on a small photodiode.
3. Noise increases with increased bandwidth. Limit the circuit bandwidth to only that required. Use a capacitor across the R_F to limit bandwidth, even if not required for stability.
4. Circuit board leakage can degrade the performance of an otherwise well-designed amplifier. Clean the circuit board carefully. A circuit board guard trace that encircles the summing junction and is driven at the same voltage can help control leakage.

For additional information, refer to the Application Bulletins *Noise Analysis of FET Transimpedance Amplifiers* (SBOA060), and *Noise Analysis for High-Speed Op Amps* (SBOA066), available for download at the TI web site.

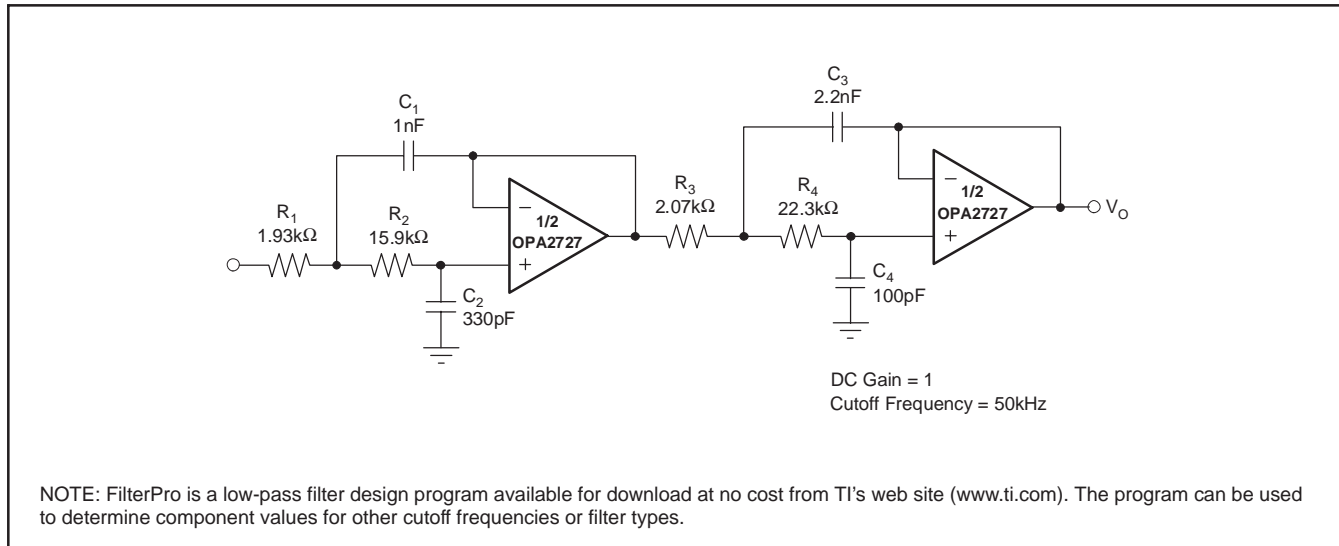

Figure 7. Four-Pole Butterworth Sallen-Key Low-Pass Filter

DFN PACKAGE

The OPA727 series uses the 8-lead DFN (also known as SON), which is a QFN package with lead contacts on only two sides of the bottom of the package. This leadless, near-chip-scale package maximizes board space and enhances thermal and electrical characteristics through an exposed pad.

DFN packages are physically small, have a smaller routing area, improved thermal performance, and improved electrical parasitics, with a pinout scheme that is consistent with other commonly-used packages, such as SO and MSOP. Additionally, the absence of external leads eliminates bent-lead issues.

The DFN package can be easily mounted using standard printed circuit board (PCB) assembly techniques. See Application Note, *QFN/SON PCB Attachment* (SLUA271) and Application Report, *Quad Flatpack No-Lead Logic Packages* (SCBA017), both available for download at www.ti.com.

The exposed leadframe die pad on the bottom of the package should be connected to V-.

LAYOUT GUIDELINES

The leadframe die pad should be soldered to a thermal pad on the PCB. A mechanical data sheet showing an example layout is attached at the end of this data sheet. Refinements to this layout may be required based on assembly process requirements. Mechanical drawings located at the end of this data sheet list the physical dimensions for the package and pad. The five holes in the landing pattern are optional, and are intended for use with thermal vias that connect the leadframe die pad to the heatsink area on the PCB.

Soldering the exposed pad significantly improves board-level reliability during temperature cycling, key push, package shear, and similar board-level tests. Even with applications that have low-power dissipation, the exposed pad must be soldered to the PCB to provide structural integrity and long-term reliability.

THERMAL INFORMATION

This package incorporates an exposed thermal pad that is designed to be attached directly to an external heatsink. The thermal pad must be soldered directly to the printed circuit board (PCB), the PCB can be used as a heatsink. In addition, through the use of thermal vias, the thermal pad can be attached directly to a ground plane or special heatsink structure designed into the PCB. This design optimizes the heat transfer from the integrated circuit (IC).

For information on the Quad Flatpack No-Lead (QFN) package and its advantages, refer to Application Report, Quad Flatpack No-Lead Logic Packages, Texas Instruments Literature No. SCBA017. This document is available at www.ti.com.

The exposed thermal pad dimensions for this package are shown in the following illustration.

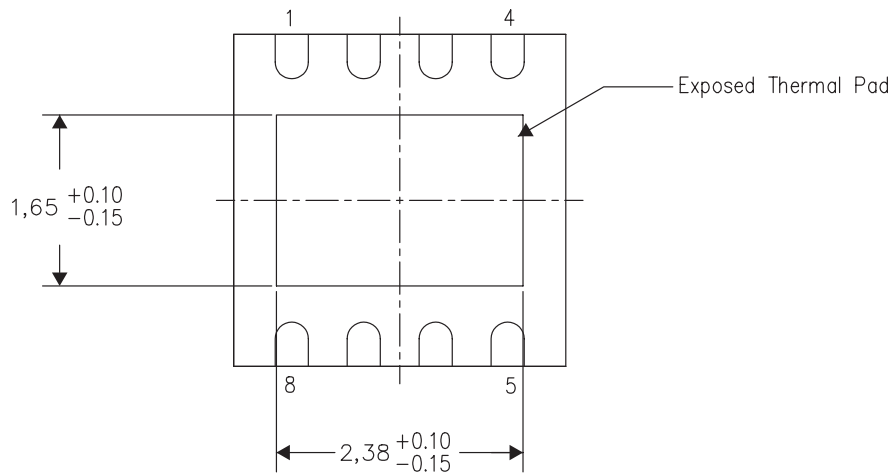

Bottom View

NOTE: All linear dimensions are in millimeters

Exposed Thermal Pad Dimensions

DRB (S-PDSO-N8)

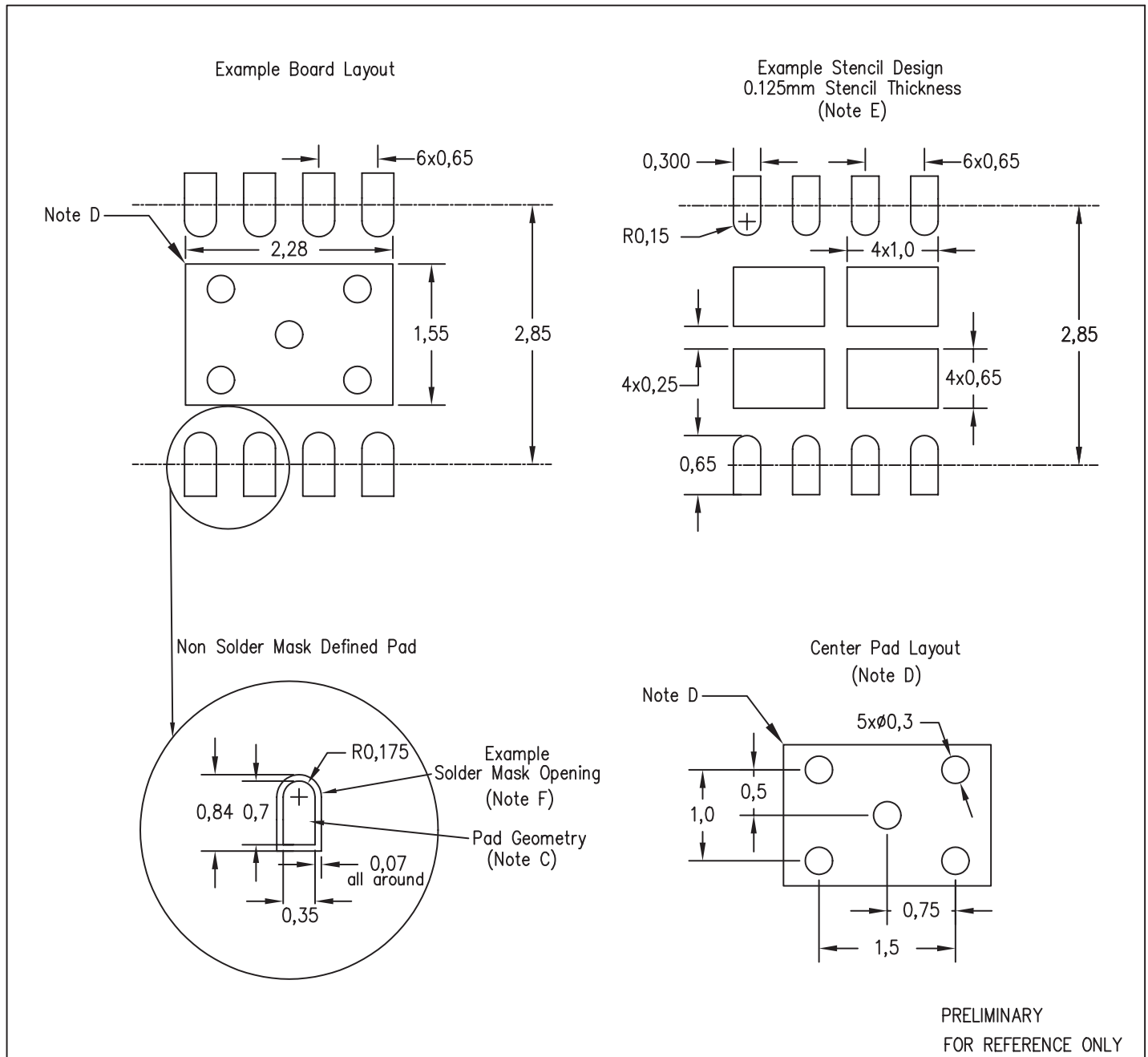

- NOTES:
- All linear dimensions are in millimeters.
 - This drawing is subject to change without notice.
 - Publication IPC-SM-782 is recommended for alternate designs.
 - This package is designed to be soldered to a thermal pad on the board. Refer to Application Note, QFN Packages, Texas Instruments Literature No. SCBA017, SLUA271, and also the Product Data Sheets for specific thermal information, via requirements, and recommended board layout. These documents are available at www.ti.com <<http://www.ti.com>>.
 - Laser cutting apertures with trapezoidal walls and also rounding corners will offer better paste release. Customers should contact their board assembly site for stencil design recommendations. Refer to IPC 7525 for stencil design considerations.
 - Customers should contact their board fabrication site for solder mask tolerances.

PACKAGING INFORMATION

| Orderable Device | Status ⁽¹⁾ | Package Type | Package Drawing | Pins | Package Qty | Eco Plan ⁽²⁾ | Lead/Ball Finish | MSL Peak Temp ⁽³⁾ |
|------------------|-----------------------|--------------|-----------------|------|-------------|-------------------------|------------------|------------------------------|
| OPA727AIDGKR | ACTIVE | MSOP | DGK | 8 | 2500 | TBD | CU NIPDAU | Level-3-240C-168 HR |
| OPA727AIDGKT | ACTIVE | MSOP | DGK | 8 | 250 | TBD | CU NIPDAU | Level-3-240C-168 HR |
| OPA727AIDRBR | ACTIVE | SON | DRB | 8 | 3000 | TBD | CU NIPDAU | Level-3-260C-168 HR |
| OPA727AIDRBT | ACTIVE | SON | DRB | 8 | 250 | TBD | CU NIPDAU | Level-3-260C-168 HR |
| OPA728AIDGKR | ACTIVE | MSOP | DGK | 8 | 2500 | TBD | CU NIPDAU | Level-3-240C-168 HR |
| OPA728AIDGKT | ACTIVE | MSOP | DGK | 8 | 250 | TBD | CU NIPDAU | Level-3-240C-168 HR |
| OPA728AIDRBR | ACTIVE | SON | DRB | 8 | 3000 | TBD | CU NIPDAU | Level-3-260C-168 HR |
| OPA728AIDRBT | ACTIVE | SON | DRB | 8 | 250 | TBD | CU NIPDAU | Level-3-260C-168 HR |

⁽¹⁾ The marketing status values are defined as follows:

ACTIVE: Product device recommended for new designs.

LIFEBUY: TI has announced that the device will be discontinued, and a lifetime-buy period is in effect.

NRND: Not recommended for new designs. Device is in production to support existing customers, but TI does not recommend using this part in a new design.

PREVIEW: Device has been announced but is not in production. Samples may or may not be available.

OBSOLETE: TI has discontinued the production of the device.

⁽²⁾ Eco Plan - The planned eco-friendly classification: Pb-Free (RoHS) or Green (RoHS & no Sb/Br) - please check <http://www.ti.com/productcontent> for the latest availability information and additional product content details.

TBD: The Pb-Free/Green conversion plan has not been defined.

Pb-Free (RoHS): TI's terms "Lead-Free" or "Pb-Free" mean semiconductor products that are compatible with the current RoHS requirements for all 6 substances, including the requirement that lead not exceed 0.1% by weight in homogeneous materials. Where designed to be soldered at high temperatures, TI Pb-Free products are suitable for use in specified lead-free processes.

Green (RoHS & no Sb/Br): TI defines "Green" to mean Pb-Free (RoHS compatible), and free of Bromine (Br) and Antimony (Sb) based flame retardants (Br or Sb do not exceed 0.1% by weight in homogeneous material)

⁽³⁾ MSL, Peak Temp. -- The Moisture Sensitivity Level rating according to the JEDEC industry standard classifications, and peak solder temperature.

Important Information and Disclaimer: The information provided on this page represents TI's knowledge and belief as of the date that it is provided. TI bases its knowledge and belief on information provided by third parties, and makes no representation or warranty as to the accuracy of such information. Efforts are underway to better integrate information from third parties. TI has taken and continues to take reasonable steps to provide representative and accurate information but may not have conducted destructive testing or chemical analysis on incoming materials and chemicals. TI and TI suppliers consider certain information to be proprietary, and thus CAS numbers and other limited information may not be available for release.

In no event shall TI's liability arising out of such information exceed the total purchase price of the TI part(s) at issue in this document sold by TI to Customer on an annual basis.

DGK (S-PDSO-G8)

PLASTIC SMALL-OUTLINE PACKAGE

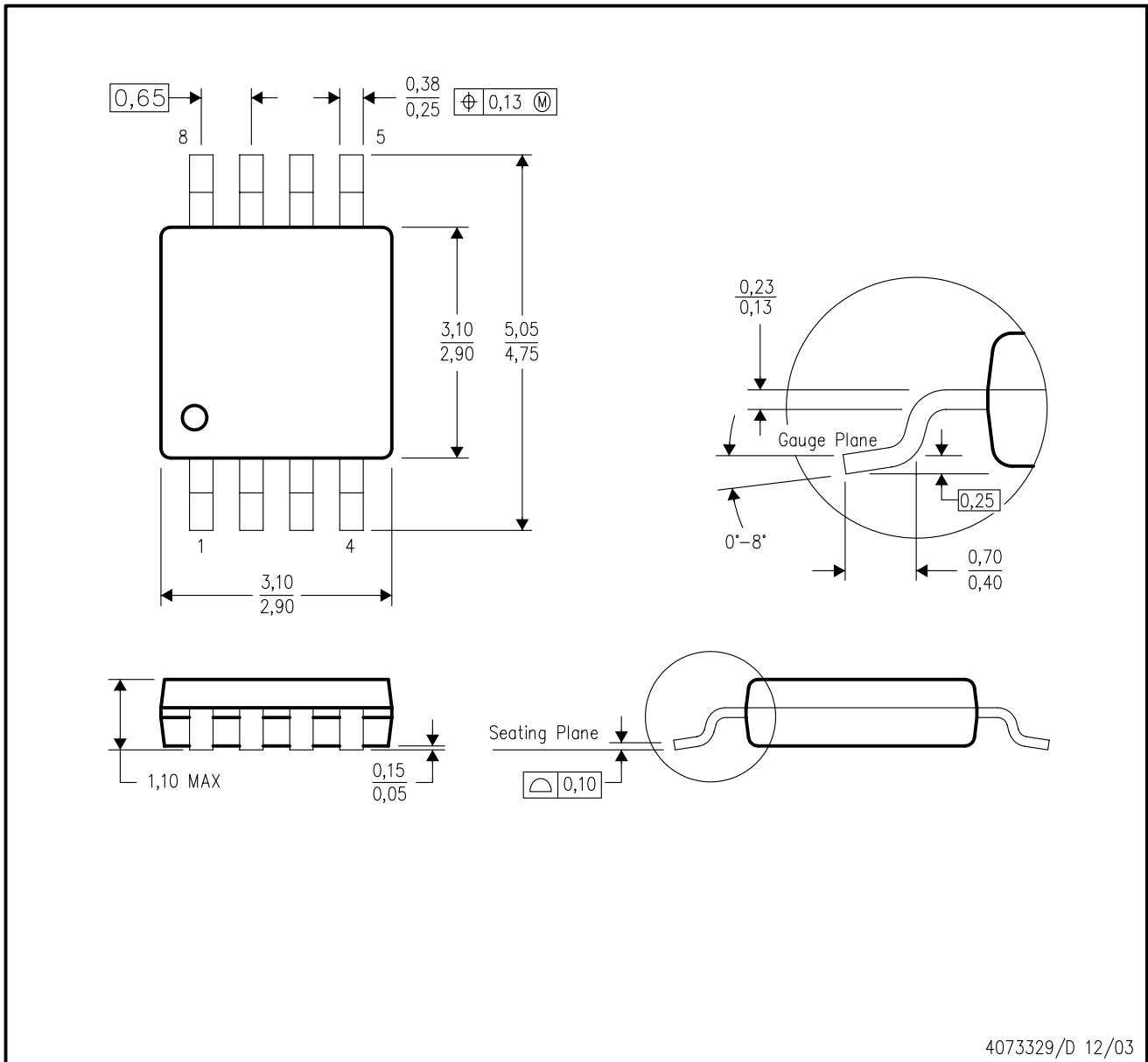

- NOTES:
- A. All linear dimensions are in millimeters.
 - B. This drawing is subject to change without notice.
 - C. Body dimensions do not include mold flash or protrusion.
 - D. Falls within JEDEC MO-187 variation AA.

DRB (S-PDSO-N8)

PLASTIC SMALL OUTLINE

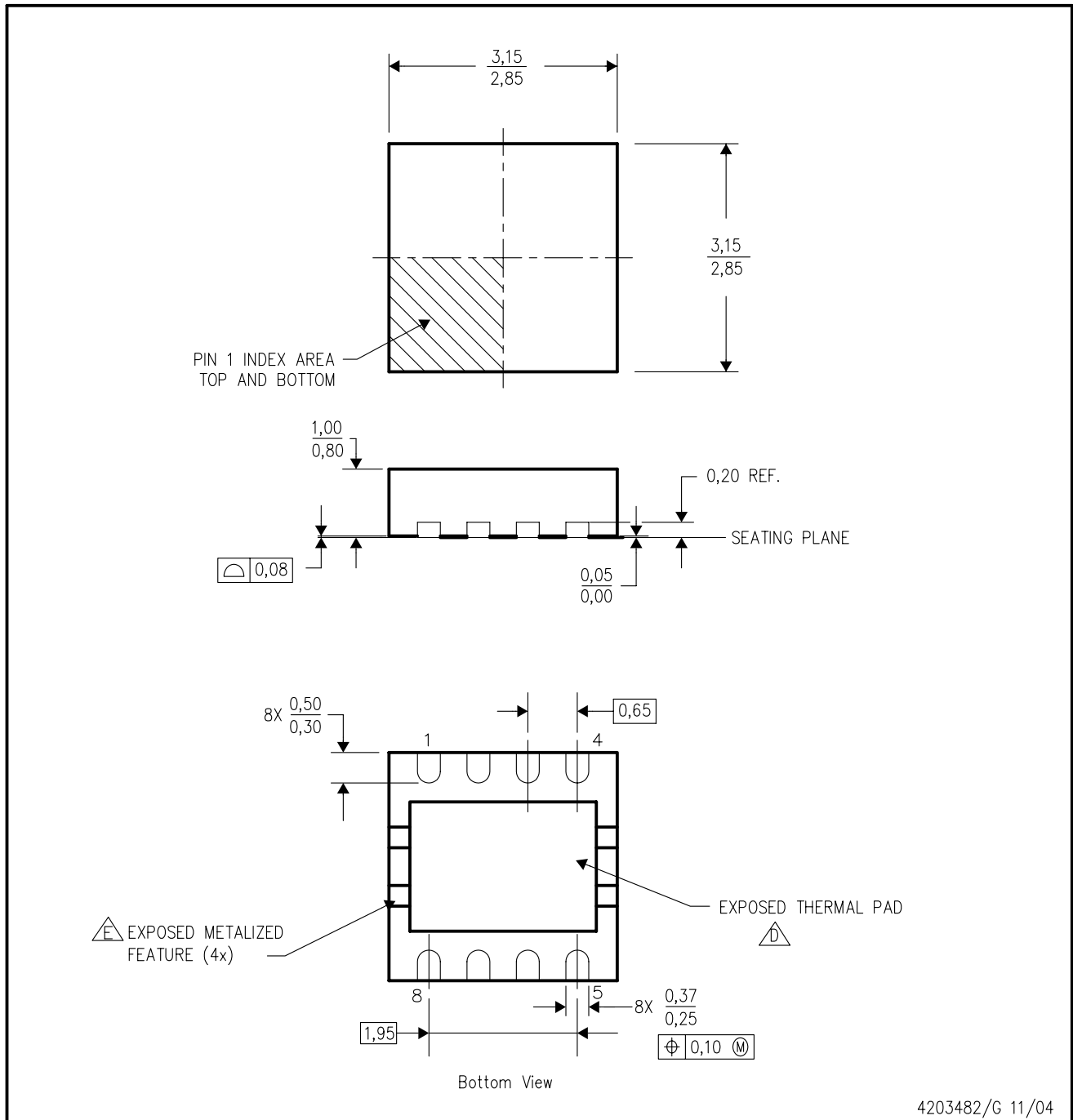

- NOTES:
- A. All linear dimensions are in millimeters. Dimensioning and tolerancing per ASME Y14.5M-1994.
 - B. This drawing is subject to change without notice.
 - C. Small Outline No-Lead (SON) package configuration.
 - The package thermal pad must be soldered to the board for thermal and mechanical performance. See the Product Data Sheet for details regarding the exposed thermal pad dimensions.
 - Metalized features are supplier options and may not be on the package.

IMPORTANT NOTICE

Texas Instruments Incorporated and its subsidiaries (TI) reserve the right to make corrections, modifications, enhancements, improvements, and other changes to its products and services at any time and to discontinue any product or service without notice. Customers should obtain the latest relevant information before placing orders and should verify that such information is current and complete. All products are sold subject to TI's terms and conditions of sale supplied at the time of order acknowledgment.

TI warrants performance of its hardware products to the specifications applicable at the time of sale in accordance with TI's standard warranty. Testing and other quality control techniques are used to the extent TI deems necessary to support this warranty. Except where mandated by government requirements, testing of all parameters of each product is not necessarily performed.

TI assumes no liability for applications assistance or customer product design. Customers are responsible for their products and applications using TI components. To minimize the risks associated with customer products and applications, customers should provide adequate design and operating safeguards.

TI does not warrant or represent that any license, either express or implied, is granted under any TI patent right, copyright, mask work right, or other TI intellectual property right relating to any combination, machine, or process in which TI products or services are used. Information published by TI regarding third-party products or services does not constitute a license from TI to use such products or services or a warranty or endorsement thereof. Use of such information may require a license from a third party under the patents or other intellectual property of the third party, or a license from TI under the patents or other intellectual property of TI.

Reproduction of information in TI data books or data sheets is permissible only if reproduction is without alteration and is accompanied by all associated warranties, conditions, limitations, and notices. Reproduction of this information with alteration is an unfair and deceptive business practice. TI is not responsible or liable for such altered documentation.

Resale of TI products or services with statements different from or beyond the parameters stated by TI for that product or service voids all express and any implied warranties for the associated TI product or service and is an unfair and deceptive business practice. TI is not responsible or liable for any such statements.

Following are URLs where you can obtain information on other Texas Instruments products and application solutions:

| Products | | Applications | |
|------------------|--|---------------------|--|
| Amplifiers | amplifier.ti.com | Audio | www.ti.com/audio |
| Data Converters | dataconverter.ti.com | Automotive | www.ti.com/automotive |
| DSP | dsp.ti.com | Broadband | www.ti.com/broadband |
| Interface | interface.ti.com | Digital Control | www.ti.com/digitalcontrol |
| Logic | logic.ti.com | Military | www.ti.com/military |
| Power Mgmt | power.ti.com | Optical Networking | www.ti.com/opticalnetwork |
| Microcontrollers | microcontroller.ti.com | Security | www.ti.com/security |
| | | Telephony | www.ti.com/telephony |
| | | Video & Imaging | www.ti.com/video |
| | | Wireless | www.ti.com/wireless |

Mailing Address: Texas Instruments
Post Office Box 655303 Dallas, Texas 75265