

Safety Guidebook

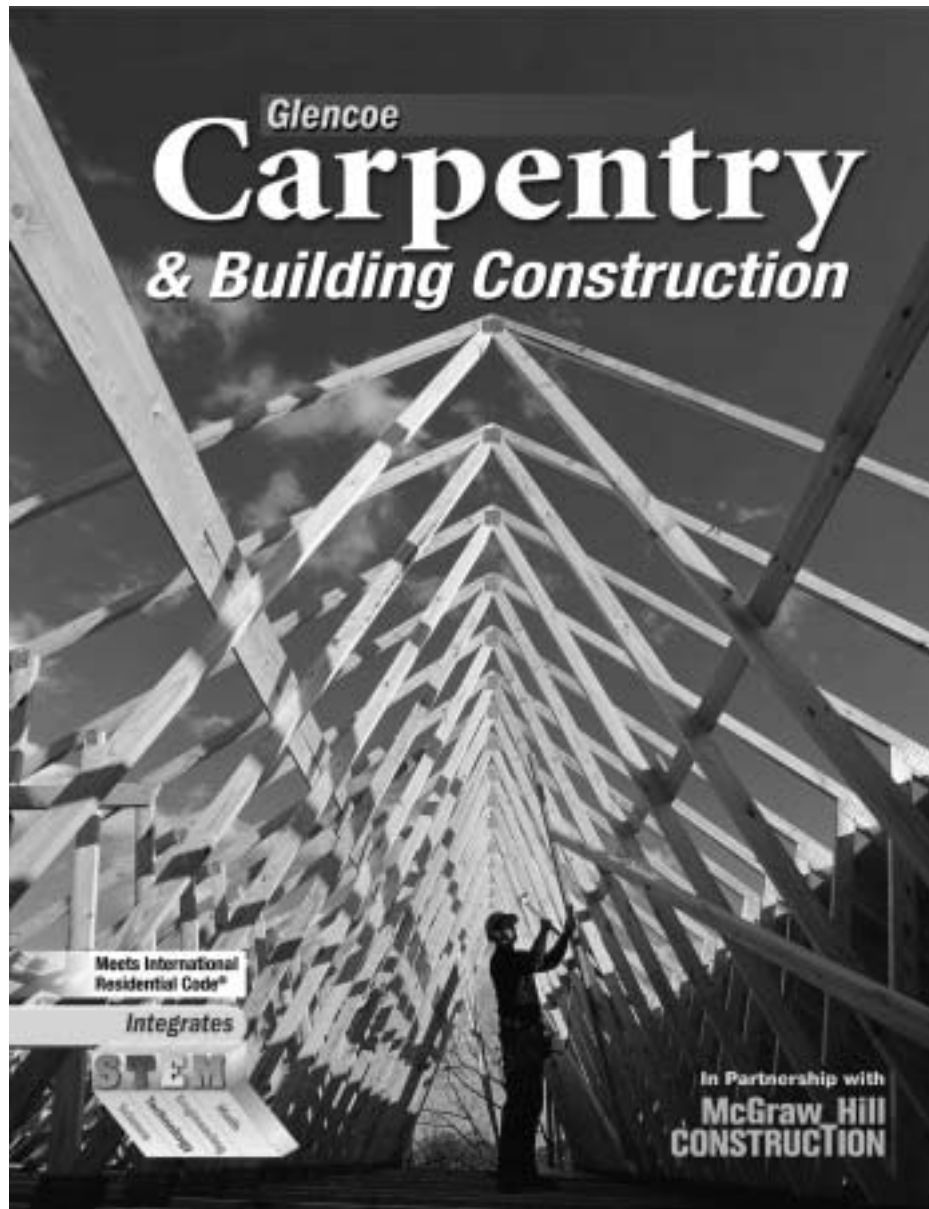

New York, New York Columbus, Ohio Chicago, Illinois Peoria, Illinois Woodland Hills, California

Acknowledgment

Publisher gratefully acknowledges Kathy Swan, member of the United Brotherhood of Carpenters and Joiners of America, for reviewing this guidebook.

Internet Listings

The Internet listings given in this guidebook are a source for extended information related to our text. We have made every effort to recommend sites that are informative and accurate. However, these sites are not under the control of Glencoe/McGraw-Hill, and therefore Glencoe/McGraw-Hill makes no representation concerning the content of these sites. We strongly encourage instructors to preview Internet sites before students use them. Many sites may eventually contain links to other sites that could lead to exposure to inappropriate material. Internet sites are sometimes “under construction” and may not always be available. Sites may also move or have been discontinued completely by the time instructors or students attempt to access them.

NOTICE

The reader is expressly advised to consider and use all safety precautions described in this guidebook or that might also be indicated by undertaking the activities described herein. In addition, common sense should be exercised to help avoid all potential hazards.

Publisher and Authors assume no responsibility for the activities of the reader or for the subject matter experts who prepared this book. Publisher and Author make no representation or warranties of any kind, including but not limited to, the warranties of fitness for particular purpose or merchantability, nor for any implied warranties related thereto, or otherwise. Publisher and Author will not be liable for damages of any type, including any consequential, special or exemplary damages resulting, in whole or in part, from reader's use or reliance upon the information, instructions, warnings or other matter contained in this book.

Credits

Courtesy of Aearo Co., 14
Reproduced with permission
Lay Rescuer Adult CPR Poster
© 2000, Copyright American Heart Assoc., 16
Arnold & Brown, 14
Art MacDillos/Gary Skillestad, 59
Courtesy of Bullard, 14
Courtesy of Delta International Machinery Corp., 89
Courtesy of DeWALT, 90
David R. Frazier Photolibrary Inc., 13

Kelly Hinkle, 25, 27, 28, 44, 46, 60, 64, 66, 67, 71, 72,
73, 76, 83, 105
Courtesy of Hitachi, 90
Courtesy of Justrite Mfg. Co., 39, 40
Courtesy of Makita Corp., 91, 92
Kevin May Corp., 34, 38, 77, 86, 92, 95
Jon Muzzarelli, 99
Courtesy of Red Wing Shoe Co., 14
Photo Edit/Elena Rooraid, 10
Barb Spink, 50



The McGraw-Hill Companies

Copyright © 2004 by Glencoe/McGraw-Hill, a division of The McGraw-Hill Companies. All rights reserved. Except as permitted under the United States Copyright Act, no part of this publication may be reproduced or distributed in any form or by any means, or stored in a database or retrieval system, without prior written permission of the publisher, Glencoe/McGraw-Hill.

Send all inquiries to:
Glencoe/McGraw-Hill
3008 W. Willow Knolls Drive
Peoria, IL 61614

ISBN 0-07-825352-7

Printed in the United States of America

2 3 4 5 6 7 8 9 10 024 09 08 07 06 05

Table of Contents

Part 1: Safety and Health on the Job.....5

| | |
|--------------------------------------|----|
| Safety: Who Is Responsible? | 6 |
| 1-1 Federal Labor Laws..... | 7 |
| 1-2 NIOSH | 8 |
| 1-3 OSHA..... | 9 |
| 1-4 Rights and Responsibilities..... | 11 |
| 1-5 Safe Work Habits | 13 |
| 1-6 Responding to Emergencies | 15 |
| 1-7 Drug-Free Workplace | 21 |
| 1-8 Workplace Violence | 22 |

Part 2: Personal Safety23

| | |
|---|----|
| Keeping Yourself and Others Safe | 24 |
| 2-1 Musculoskeletal Disorders | 25 |
| 2-2 Personal Protective Equipment | 27 |
| 2-3 Protection from the Environment | 29 |

Part 3: Keeping the Worksite Safe31

| | |
|---|----|
| No Way Out | 32 |
| 3-1 Housekeeping, Illumination, Sanitation..... | 33 |
| 3-2 Electrical Safety..... | 35 |
| 3-3 Fire Protection and Prevention..... | 39 |
| 3-4 Hazardous Materials Identification..... | 43 |
| 3-5 Safety Color Codes | 45 |
| 3-6 Accident Prevention Tags..... | 46 |
| 3-7 Confined Spaces | 47 |
| 3-8 Excavations..... | 49 |
| 3-9 Barricades..... | 53 |
| 3-10 Demolition of Structures..... | 54 |

Part 4: Avoiding Falls55

| | |
|---------------------------------------|----|
| One Wrong Step | 56 |
| 4-1 Ladders..... | 57 |
| 4-2 Scaffolds..... | 61 |
| 4-3 Working on Roofs | 65 |
| 4-4 Excavation and Trench Areas | 67 |

Part 5: Tool and Equipment Safety.....69

| | |
|---|-----|
| Dangerous Power | 70 |
| 5-1 Hand Tools | 71 |
| 5-2 Sawing Tools..... | 73 |
| 5-3 Edge-Cutting and Shaping Tools | 74 |
| 5-4 Assembly, Fastening, and Disassembly Tools..... | 75 |
| 5-5 Drilling and Boring Tools | 77 |
| 5-6 Wrenches, Pliers, and Snips | 78 |
| 5-7 Electric Tools | 79 |
| 5-8 Pneumatic Tools | 80 |
| 5-9 Powered Abrasive Wheel Tools | 81 |
| 5-10 Liquid Fuel Tools..... | 82 |
| 5-11 Hydraulic Tools | 83 |
| 5-12 Powder-Actuated Tools..... | 84 |
| 5-13 Circular Saws | 85 |
| 5-14 Table Saws | 87 |
| 5-15 Radial-Arm Saws..... | 89 |
| 5-16 Miter Saws | 90 |
| 5-17 Jigsaws and Reciprocating Saws | 91 |
| 5-18 Electric Drills | 92 |
| 5-19 Routers | 93 |
| 5-20 Sanders..... | 94 |
| 5-21 Jointers..... | 95 |
| 5-22 Electric Planers and Planes..... | 96 |
| 5-23 Plate Joiners | 97 |
| 5-24 Lasers | 98 |
| 5-25 Power Nailers and Staplers..... | 99 |
| 5-26 Welding Tools and Equipment..... | 101 |

Part 6: Materials Handling103

| | |
|---|-----|
| One Wrong Move..... | 104 |
| 6-1 Storing Nonhazardous Materials..... | 105 |
| 6-2 Waste Disposal | 106 |
| 6-3 Hazardous Materials..... | 107 |
| 6-4 Bulk Lifting/Moving Operations..... | 109 |

| | |
|-----------------------|------------|
| Glossary | 111 |
|-----------------------|------------|

Safety and Health on the Job

Safety: Who Is Responsible?.....6
1-1 Federal Labor Laws.....7
1-2 NIOSH8
1-3 OSHA9
1-4 Rights and Responsibilities.....11
1-5 Safe Work Habits13
1-6 Responding to Emergencies15
1-7 Drug-Free Workplace21
1-8 Workplace Violence22

Safety: Who Is Responsible?

A laborer was working at a building renovation job. He was using a jackhammer to chip away an old concrete and brick floor from a horizontal I-beam. To do this task, he stood on a six-inch wide plank laid between two adjacent I-beams. He lost his balance, falling 14 feet to the concrete floor below and sustaining fatal head injuries.

What factors contributed to this fatal accident?

- The laborer was not wearing any fall protection gear.
- The floor openings were not guarded by railings and toe boards or covers.
- There were no regular worksite inspections.
- There was nobody on the job site who had been trained to identify hazards and who was authorized to take prompt action to eliminate them.
- There was no safety and health program in effect.

To keep a worksite safe, people need to recognize hazards and know how to protect themselves. Employers can provide that knowledge through education and training programs. It is up to the employees, however, to put that knowledge to use, every day and in everything they do.

Safety is everyone's responsibility.

Accidents such as this one could be avoided by following OSHA regulations 1926.20 (safety program with regular inspections), 1926.28 (personal protective equipment), and 1926.500 (fall protection).



SAFETY

FIRST

FOLLOW RULES

Federal Labor Laws

For additional information, refer to the U.S. Department of Labor's website at www.dol.gov.

NOTES

The federal government has created a number of laws to protect workers from unfair and unsafe practices.

FAIR LABOR STANDARDS ACT

- Sets rules that protect workers under the age of 18 from hazardous occupations and long working hours.
- Provides exemptions in some hazardous occupations for apprentices and vocational education students.
- Prohibits workers under age 16 from working on construction sites.
- Sets the federal minimum wage.

FEDERAL EQUAL EMPLOYMENT OPPORTUNITY LAWS

- Prohibit job discrimination on the basis of race, color, religion, sex, national origin, disability, or age.
- Enforced by the U.S. Equal Employment Opportunity Commission.

FAMILY AND MEDICAL LEAVE ACT

- States that employers must provide up to 12 weeks of unpaid, job-protected leave to eligible employees for certain family and medical reasons.
- Applies to government employers, public schools, and businesses with 50 or more employees.

OCCUPATIONAL SAFETY AND HEALTH ACT

- Provides safety and health protection for workers.
- See Safety Sheet 1-3 for additional information.

By law, employers must display notices explaining these laws at the workplace in a place where they can easily be seen.

NIOSH

NOTES

For additional information, refer to the NIOSH website at www.cdc.gov/niosh/homepage.html.

NIOSH is the National Institute for Occupational Safety and Health. It is separate from OSHA, though both were developed through the Occupational Safety and Health Act. The purpose of NIOSH is to discover causes of occupational injuries and illnesses and provide training to prevent them.

RESPONSIBILITIES

The responsibilities of NIOSH include:

- Enumerating the hazards in the workplace.
- Identifying causes of work-related diseases and injuries.
- Evaluating hazards of new technologies and work practices.
- Creating ways to control hazards.
- Training safety and health professionals.
- Recommending occupational safety and health standards.

NIOSH AND CONSTRUCTION

More than 7 million people work in the construction industry. They make up only about 6 percent of the entire workforce, but they receive 15 percent of the total dollars spent on workers' compensation. On a construction site, several different crews may work in a small area. The types of hazards at the site change, depending on the kind of work being done. Many projects are short-term. All these factors contribute to the difficulty of ensuring that worksites are safe.

In 1990, Congress directed NIOSH to conduct research and training to reduce injuries, fatalities, and diseases in the industry. NIOSH has developed new strategies in areas such as reducing workers' exposure to hazardous substances. It also has worked to identify causes of and ways to prevent injuries and deaths from falls, cave-ins, and electrocutions.

Through research, including field evaluations of accidents and fatalities, NIOSH has produced numerous publications, including "Alerts" on specific topics. These Alerts describe how accidents might occur and how to prevent them.

You can find NIOSH publications at www.cdc.gov/niosh/pubs.html.

OSHA

For additional information, refer to the Occupational Safety and Health Administration’s website at www.osha.gov.

NOTES

The Occupational Safety and Health Administration (OSHA) was created in response to public protest over rising injury and death rates in the U.S. workplace. In 1970, the United States Congress enacted the Occupational Safety and Health Act to “assure so far as possible every working man and woman in the Nation safe and healthful working conditions and to preserve our human resources.” The OSH Act covers all employers and employees in the 50 States, the District of Columbia, Puerto Rico, and all other territories under the U.S. government’s jurisdiction. It provides not only for safe working conditions and inspections but also for reviews of and penalties against employers who violate the law. OSHA administers this act.

OSHA sets and enforces the standards in the act and conducts workplace inspections to ensure employers’ compliance with those standards. OSHA also conducts training programs to educate employers about workplace safety and health issues so that accidents and injuries can be prevented. It researches emerging safety and health issues to confront problems as technology changes.

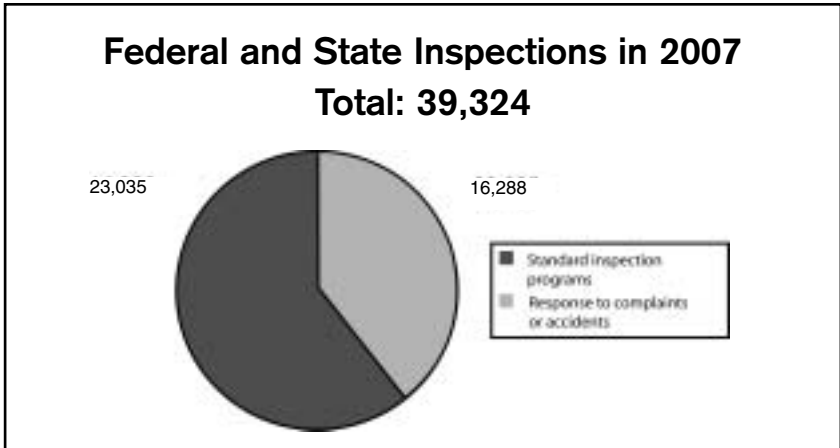

(Continued on next page)

NOTES

Over 30 years, the U.S. workforce has grown from 56 million to 105 million workers. Even so, OSHA has seen workplace fatalities reduced by 60 percent and occupational injury and illness rates by 40 percent.

Because of the high incidence of accidents and injuries in the construction industry (1,190 fatalities and 501,400 injuries and illnesses in 1999), special provisions were created to protect construction workers. OSHA adopted regulations from the 1962 Contract Work Hours and Safety Standards Act and its 1969 amendment, the Construction Safety Act, when it created Part 1926 Safety and Health Regulations for Construction.

You can access the OSHA document *Selected Construction Regulations for the Home Building Industry* online at <http://www.osha-slc.gov/Publications/Homebuilders/Homebuilders.html>.



OSHA inspectors make sure worksites are safe for workers.

Rights and Responsibilities

For additional information, refer to OSHA regulations 1910.1200, 1926.20, 1926.21, and 1926.32.

NOTES

EMPLOYER RESPONSIBILITIES

Included in the Occupational Safety and Health Act is a “general duty” clause that covers hazards for which standards have not been developed. Employers shall:

- Provide a workplace that is free from recognized hazards that cause or are likely to cause death or serious physical harm to employees.
- Comply with occupational safety and health standards established by the act.

Specifically, employers must first provide for overall safety of the worksite, including measures for housekeeping, first aid, sanitation, sufficient lighting, fire protection and prevention, and emergency egress (escape). Employers are also responsible for providing frequent and regular inspections of job sites, materials, and equipment by competent persons. Additional standards that employers must follow include providing every worker:

- Access to his or her medical and exposure records.
- Personal protective equipment appropriate for the job.
- Safety training.
- Hazard communication.

The Hazard Communication Standards are also known as Right to Know laws. They require employers to notify and train workers about the identities and the hazards of chemicals they may be exposed to on the job site.

EMPLOYEE RIGHTS

Employees have the right to:

- Contact OSHA about violations of safety and health conditions and have their identity kept confidential from the employer.
- Contest the time period OSHA allows for correcting standards violations.
- Participate in OSHA workplace inspections.

(Continued on next page)

NOTES

EMPLOYEE RESPONSIBILITIES

Along with employees' rights come responsibilities. Each employee must, in all of his or her own actions:

- Comply with OSHA regulations.
- Comply with all other safety and health standards.

In other words, you as an employee have the right to a safe workplace, but, at the same time, you must also do your part to keep the job site safe for yourself, your coworkers, and your employer.

SAFETY TRAINING

Employers must provide safety training to ensure that employees can work responsibly and be safe. To be able to recognize, avoid, and prevent unsafe and unhealthful conditions, workers must be trained in:

- Safe handling of various materials, including chemicals and flammable materials.
- Safe operation of tools and equipment.
- Potential hazards of harmful plants or animals.
- Hazards of confined or enclosed spaces.
- Other protective measures to take for specific tasks.

OSHA provides the following definitions to ensure that the proper persons perform specific tasks on the worksite:

- *Authorized persons* and *designated persons* are approved or assigned by the employer to perform a specific type of duty or to be at a specific location.
- *Competent persons* are capable of identifying existing and predictable hazards and are *authorized* to correct or eliminate these problems.
- *Qualified persons* are those with a degree, certificate, or professional standing; or through knowledge, training, and experience, these persons have demonstrated the ability to solve or resolve problems relating to the project.

To become a competent person or a qualified person, you may receive training through OSHA or various trade unions and associations. The Board of Certified Safety Professionals offers additional training for basic certification as well as specialty certifications. Before you can correct or eliminate problems or hazards, however, you must be authorized by your employer.

Safe Work Habits

For additional information, refer to OSHA regulations 1926.25, 1926.27, and 1926.28.

Unsafe acts are the number one cause of accidents and injuries on the job. Get into the habit of working safely. You'll benefit yourself and your coworkers.

DEVELOP A SAFE ATTITUDE

- Work quietly and give your full attention to the task at hand.
- Never indulge in horseplay or other foolish actions. Someone could get seriously hurt.
- Before using a tool or a piece of equipment, make sure you understand how to operate it safely.

KEEP YOURSELF AND THE WORK AREA NEAT AND CLEAN

- Fewer accidents occur at job sites that are well maintained.
- To prevent slips and falls, promptly clean up any spills and keep tools, materials, and debris away from areas where people walk.
- Always clean your hands before eating to avoid ingesting hazardous substances.



NOTES

(Continued on next page)

NOTES

DRESS FOR THE JOB

- If working outdoors, dress appropriately for the weather.
- Avoid wearing pants or overalls that are too long. They will tend to catch heels and cause falls. Avoid cuffs because they can collect debris such as sawdust and metal shavings.
- Clothing should not be so loose that it catches on nails or dangles near power tools. Keep the sleeves of shirts or jackets buttoned, or roll them up.
- Wear work boots with thick, sturdy soles. When working on a roof, wear boots with slip-resistant soles. Boots with safety toe caps protect feet from injuries caused by falling tools and materials.
- Tie back long hair in place, or cut it short.
- Rings, watches, neck chains, and other jewelry can catch on tools or materials. Avoid wearing them.
- Always use appropriate, approved personal protective equipment for your eyes, ears, face, head, and feet. Respirators must be approved by the National Institute for Occupational Safety and Health (NIOSH). Other personal protective equipment must meet standards set by the American National Standards Institute (ANSI).

**Hearing Protector****Hardhat****Respirator****Safety Goggles****Safety-Toe Footwear**

Responding to Emergencies

For additional information, refer to OSHA regulations 1926.23 and 1926.50.

NOTES

Even when everyone on a job site is careful, accidents can happen. If someone is injured, first aid can reduce the possibility of permanent disability or death. OSHA requires employers to have an emergency response plan for every worksite. Make sure you know how to get help. A first-aid kit and at least one trained first-aid responder must be on site if a medical facility that can treat injured workers is not “reasonably accessible.”

GENERAL FIRST-AID ACTIONS

Listed below are steps you can take if you're the first person on the scene of an injury, until trained first responders or medical personnel arrive. When dealing with an injured person, remember that the first rule is to *do no harm*. Careless or incorrect treatment can worsen the injury.

- Call 911 or the nearest medical facility.
- Examine the victim carefully to evaluate injury.
- Keep the injured person lying down.
- Do not give liquids to someone who is unconscious.
- Treat for traumatic shock. (See page 17.)
- Keep pressure on a wound to control bleeding.
- For eye injuries, pad and bandage both eyes.
- If the person is not breathing, administer CPR, *if you are qualified*. (See below.)
- Keep checking and assisting the victim until medical help arrives.

CARDIOPULMONARY RESUSCITATION (CPR)

CPR is a procedure designed to help a victim breathe and to restart the heart. It's a skill everyone should learn, especially those whose work may involve even moderately hazardous materials or duties.

(Continued on next page)

NOTES

CAUTION: To learn CPR, you need to be trained by qualified professionals. Injury can be caused if CPR is administered incorrectly. **Never** attempt CPR on a person who is breathing. Contact your local American Heart Association, American Red Cross, or hospital for information about classes.

Lay Rescuer CPR for Adult



If you find an unresponsive adult, place flat on back on a firm surface. If the adult is injured, move only if necessary, and turn head, neck, and body as a unit.



1. Phone 911 or your local emergency response number (or send someone to phone)

- Get the AED if available
- Return to victim



2. A Open the Airway

- Head tilt–chin lift
- If head or neck injury is suspected, use jaw thrust



3. B Check for Breathing (Look, Listen, Feel)

If the victim is not breathing normally, provide 2 slow rescue breaths (2 seconds each)

- Be sure the chest rises with each breath
- If chest does not rise, reopen airway, try again
- Use barrier device if available



4. C Check for Signs of Circulation

(normal breathing, coughing, or movement)

- Signs of circulation present but no breathing: provide rescue breathing (1 breath every 5 seconds)
- No signs of circulation present: perform chest compressions*
 - Compress lower half of breastbone (at nipple line)
 - Rate of about 100 times per minute
 - 15 compressions, then 2 rescue breaths (repeat)

*If AED is available: POWER ON, attach electrodes, follow prompts



5. CPR: Provide 15 compressions and 2 breaths (repeat)

Check for response every 1 to 2 minutes. Continue until rescue personnel arrive.

750254 R442 05-07-11 © 2000 American Heart Association

Reproduced with permission
Lay Rescuer Adult CPR Poster
© 2000, Copyright American Heart Association

(Continued on next page)

SHOCK

A person can go into shock when the body fails to supply enough blood to the brain and other vital organs. Shock can result from injury, dehydration, sudden impact, or allergic reactions, and it can be fatal. Symptoms include nausea, weak or rapid pulse, dizziness, chills, shallow or labored breathing, pale skin, confusion, thirst, and unconsciousness.

In case of shock:

- Keep the person warm, lying on the back if possible.
- Elevate legs higher than the heart to keep blood flowing to the organs.

BLOODBORNE PATHOGENS

Bloodborne pathogens are microorganisms, such as viruses and bacteria, which are present in human blood and can cause disease in humans. They can be passed from one person to another through blood and other fluids. Although OSHA does not have specific standards that relate to construction workers, the “general duty” clause covers anyone who might be exposed to these pathogens. Employers should make available personal protective equipment, such as goggles and disposable gloves, so that workers assisting the injured will be protected from possible exposure.

FALLS

Falls are the most common cause of injury on a construction site, but determining the extent of injuries is difficult. The person may have broken bones or spinal or internal injuries. To avoid injuring the victim further:

- Do not move the person at all, unless he or she would be in further danger.
- Keep the person from moving by surrounding both the head and the body with folded clothes or blankets.
- Treat any bleeding.
- Keep the person warm and treat for shock.

CUTS AND SCRAPES

Minor scrapes and cuts usually will not require professional medical treatment. You can:

- Stop the bleeding with gentle pressure applied directly to the wound, using a clean cloth or bandage.

NOTES

(Continued on next page)

NOTES

- Clean the wound with clear water (not soap).
- Apply an antibiotic to keep the surface moist and to discourage infection.
- Cover the wound with a bandage to keep it clean.
- Elevate the wound higher than the heart to slow bleeding.

BURNS

For minor burns (first degree and second degree up to an area no larger than 2 or 3 inches):

- Cool the burn under cold running water for 15 minutes or by immersing in cold water.
- Cover loosely with a sterile gauze bandage.
- Have the person take an over-the-counter pain reliever.

For major (third-degree) burns:

- Call 911.
- Don't remove burnt clothing.
- If necessary and *you are trained* to do so, clear the person's airway and do CPR.
- Cover the burn with a sterile bandage.
- Treat for shock.

ELECTRICAL SHOCK

In case of electrical shock:

- Examine but do not touch the person—he or she might still be in contact with the electrical source. Remember, you can't help the person by becoming a victim yourself.
- Turn off the source of electricity if possible and if it can be done safely. High power will require professionals.
- If unable to disconnect power, break the contact if possible by using a *nonconductive* item, such as a piece of *dry* wood, to push the electrical source away from the victim.
- Check breathing. If breathing has stopped, begin CPR immediately *if you are qualified* to do so.
- Treat for shock.
- Treat major burns as described above.

HEAT STRESS

When the body becomes so hot that it produces more energy (heat) than it can lose, a person suffers heat stress, or hyperthermia. There are three stages: heat cramps, heat exhaustion, and heat stroke. See the table on the next page.

(Continued on next page)

| Heat Stress | | |
|-----------------|--|--|
| Stage | Symptoms | First Aid |
| Heat cramps | <ul style="list-style-type: none"> ♦ Muscle cramps or spasms, especially in legs and abdomen | <ul style="list-style-type: none"> ♦ Rest. ♦ Drink small amounts of cool water or sports drink. ♦ Gently stretch muscle and hold for 20 seconds, then gently massage. Repeat as needed. |
| Heat exhaustion | <ul style="list-style-type: none"> ♦ Cool, moist, pale or flushed skin ♦ Headache, nausea ♦ Heavy sweating, slightly elevated body temperature ♦ Dizziness and weakness or exhaustion | <ul style="list-style-type: none"> ♦ Get the person to a cooler place. ♦ Give the person small amounts of cool water, about 1/2 glass every 15 minutes. (No alcohol or caffeine.) ♦ Remove or loosen tight clothing. ♦ Apply cool, wet cloths. |
| Heat stroke | <ul style="list-style-type: none"> ♦ Vomiting ♦ Decreased alertness, confusion, loss of consciousness ♦ Extremely high body temperature ♦ Convulsion ♦ Skin can be moist or (if sweating has stopped), red, hot, and dry ♦ Rapid, weak pulse ♦ Rapid, shallow breathing | <ul style="list-style-type: none"> ♦ Life-threatening. Get medical help immediately. Call 911. ♦ Get person to a cooler place. ♦ Quickly cool body by wrapping in wet sheets and fanning. ♦ Put ice packs or cold packs wrapped in cloth on wrists, ankles, armpits, and neck to cool large blood vessels. ♦ Check for breathing problems. ♦ Keep person lying down. |

COLD STRESS

When the body becomes so cold that it loses more energy (heat) than it produces, a person suffers cold stress, or hypothermia. This can happen even when temperatures are above freezing, particularly if the person gets wet, is exposed to wind, or is fatigued. There are three stages:

NOTES

(Continued on next page)

| Cold Stress | | |
|-------------|--|---|
| Stage | Symptoms | First Aid |
| Mild | <ul style="list-style-type: none"> ♦ Shivering ♦ Grogginess, poor judgment, disorientation ♦ Normal breathing and pulse | <ul style="list-style-type: none"> ♦ Be gentle with the person. ♦ Keep exertion to a minimum. ♦ Move the person to a warm, dry environment. ♦ Remove wet clothing, and get the person into warm, dry clothing and warm blankets. Cover the head. ♦ Put something warm and dry under the person. ♦ Do not suppress shivering—it helps warm the body. ♦ Do not massage the extremities. ♦ Do not get the person into a warm bath or shower. |
| Moderate | <ul style="list-style-type: none"> ♦ Violent shivering or shivering has stopped ♦ Inability to think and understand, irrational behavior ♦ Slow, shallow breathing ♦ Slow, weak pulse ♦ Slurred speech, poor coordination | <p><i>For both moderate and severe stages, do all of the above plus the following:</i></p> <ul style="list-style-type: none"> ♦ Life-threatening—call 911. ♦ Check for airway obstruction or breathing problems. ♦ Do not give food or liquids, which might induce vomiting. |
| Severe | <ul style="list-style-type: none"> ♦ Shivering has stopped ♦ Unconsciousness ♦ Little or no breathing ♦ Weak, irregular, or nonexistent pulse ♦ Dilated (wide open) pupils | <ul style="list-style-type: none"> ♦ Do not massage extremities or trunk. ♦ Continue treatment even if the person appears lifeless or tries to resist help. |

Drug-Free Workplace

For additional information, refer to the U.S. Substance Abuse and Mental Health Services Administration website at www.samhsa.gov.

The U.S. Drug Enforcement Administration defines drug abuse as “any activity involving illegal drugs, chronic or improper use of alcohol, and misuse of over-the-counter and prescription medications.”

EFFECTS OF ALCOHOL AND DRUG ABUSE

- On-the-job substance abuse costs employers 100 billion dollars a year in accidents, theft, health-care costs, and lowered productivity.
- Employees who test positive for drug use tend to be responsible for more accidents, to use more sick leave, and to have more unexcused absences than others.
- The highest rate of illicit drug use across all occupational groups is that of construction workers—15.6 percent. The same group has the highest above-average rate of heavy alcohol use. Substance abuse and construction work make a dangerous mix.
- The inability to concentrate, altered reaction time, and poor judgment—all common effects of substance abuse—endanger your safety and the safety of others.
- The emotional effects of substance abuse strain personal relationships and can lead to such feelings as irritation, anxiety, and depression. These feelings can, in turn, affect job performance and safety.
- Addiction takes its toll psychologically and physically. Dependence on these substances can lead to violence, illness, and even death.

EMPLOYERS’ RESPONSIBILITIES

Many employers adopt federal guidelines for maintaining a drug- and alcohol-free workplace to ensure the safety of their employees. These guidelines suggest establishing drug testing, employee education and training, and employee assistance and treatment programs. The American National Standards Institute (ANSI) includes substance abuse prevention in their construction standards.

NOTES

Workplace Violence

NOTES

For additional information, refer to OSHA's website page at www.osha.gov/oshinfo/priorities/violence.html.

Workplace violence includes not only homicide, which the media cover extensively, but also other, more frequently committed acts of aggression. The Workplace Violence Research Institute names all types of physical or verbal assaults, threats, coercion, intimidation, and harassment in its definition: "any act against an employee that creates a hostile work environment and negatively affects the employee, either physically or psychologically."

EFFECTS OF WORKPLACE VIOLENCE

- Homicide is the second leading cause of fatal occupational injury. Fortunately, the construction industry has the next to lowest homicide rate across all industries.
- More than one million workers are victims of workplace violence each year.
- Aside from the direct results of violence, victims also can suffer from emotional trauma that may affect job performance.
- Coworkers, too, can experience feelings of fear and anxiety after witnessing workplace violence.
- Economic losses due to workplace violence, such as medical and legal costs, increased absenteeism, and less productivity, are enormous to both the public and the private sectors.

PREVENTING WORKPLACE VIOLENCE

An employer's responsibility falls under OSHA's "general duty" clause to provide a workplace that is "free from recognized hazards that are causing or are likely to cause death or serious physical harm." OSHA encourages employers to create prevention programs that include pre-employment screening, employee training to recognize signs of stress and potential violence, and carefully planned termination procedures.

Personal Safety

Keeping Yourself and Others Safe.....24
2-1 Musculoskeletal Disorders.....25
2-2 Personal Protective Equipment.....27
2-3 Protection from the Environment.....29

Keeping Yourself and Others Safe

It was a typical construction site. A carpenter was building plywood forms in preparation for pouring a concrete wall. He was using a powder-actuated tool to drive nails into the form. Because the form was hollow, the nail passed completely through it. The nail traveled 27 feet before striking a 22-year-old apprentice in the head, killing him.

Several factors played a role in this fatal accident:

- The tool operator had never received training in the proper use of the powder-actuated tool.
- Neither worker was wearing any personal protective equipment.
- There had been no worksite inspections.
- There was nobody on the job site who had been trained to identify hazards and who was authorized to take prompt action to eliminate them.
- There was no safety training and education program for employees.

Never operate power tools without proper training and the correct personal protective equipment. Know and observe all safety rules. Stay aware of others who are working nearby so that your actions don't put them at risk.

Help keep your coworkers safe.

Accidents such as this one could be avoided by following OSHA regulations 1926.20 (safety program and inspections), 1926.100 and 1926.102 (personal protective equipment), and 1926.302 (training).

Musculoskeletal Disorders

OSHA currently has no regulations addressing musculoskeletal disorders and other ergonomic issues. However, some states do have their own ergonomics standards. (For a definition of *ergonomics*, see the glossary in this guidebook.)

Carpenters and construction workers are at high risk for developing musculoskeletal disorders. A musculoskeletal disorder (MSD) is a problem with muscles, tendons, ligaments, joints, cartilage, or spinal discs.

WRISTS AND ELBOWS

Doing a task over and over can cause irritation to nerves and tissues at or near joints. Damage caused in this way is called repetitive stress injury (RSI). Wrists and elbows are especially prone to RSI. Repeatedly using a tool such as a hammer, for example, can cause RSI.

A common RSI is carpal tunnel syndrome (CTS). The carpal tunnel consists of eight bones in the wrist, called carpals. These bones are held in place by a band of connective tissue called a ligament. Between the bones (that is, through the carpal tunnel) pass tendons, which control finger movement, and the median nerve that eventually separates into hand and finger nerves. Repeatedly and forcefully using hands to grip and apply pressure (such as when using tools) or performing tasks that require repeated bending of the wrist can irritate the thin membrane covering on the tendons. The membrane swells and puts pressure on the median nerve, causing carpal tunnel syndrome. Symptoms include tingling in the hand, weakness in the fingers, and/or pain that goes up the arm.

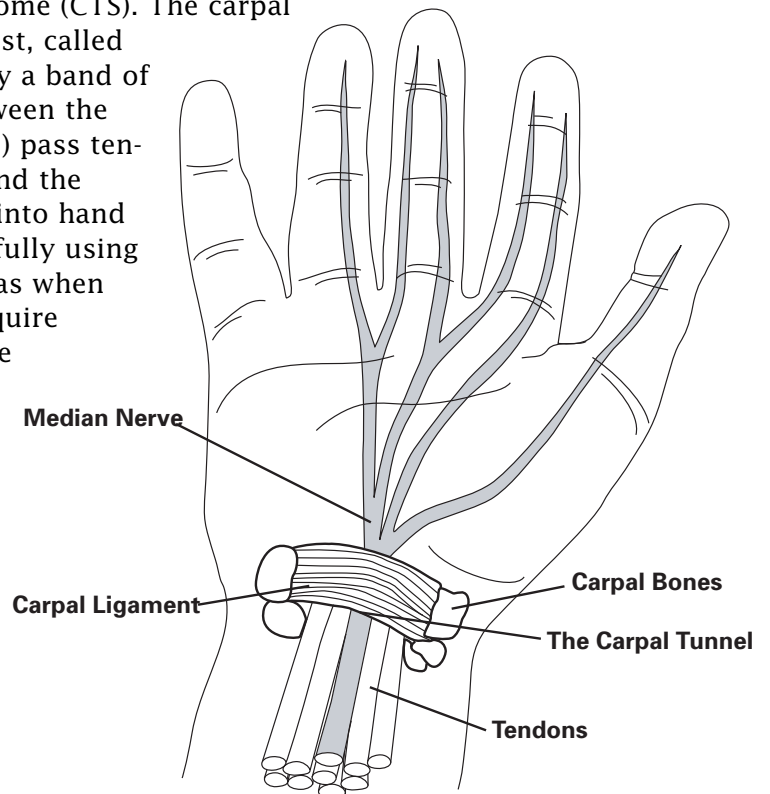

(Continued on next page)

NOTES

NOTES

Follow these guidelines to minimize the risk of developing carpal tunnel syndrome or other arm and wrist RSIs:

- Use ergonomically “friendly” tools designed with cushioned grips and properly angled handles.
- When hammering nails or tightening screws, use power tools. However, try to avoid excessive vibrations.
- Minimize wrist movement as much as possible.
- Avoid using awkward wrist and arm positions to perform tasks, especially when applying force.
- Rest hands and wrists frequently when doing repetitive work.

BACKS

Back injuries are the most common ailments of carpenters and construction workers. Back muscles can become strained. More seriously, discs that cushion vertebrae (bones) in the spine can weaken under stress and herniate (balloon out at a weak point), pressing on nerves. To minimize the risk of back injury, follow these guidelines:

- Strengthen your abdominal muscles with exercise. Strong abdominal muscles help protect your back when lifting.
- When lifting loads, always lift with your legs, not your back. Bend knees and keep your back straight as you lift. Avoid twisting movements.
- Do not attempt to lift a load if you have no idea of its actual weight. Get help from coworkers or use mechanized lifters to lift heavy or stacked loads.
- Always lift and move long objects with another person. Lift at the same time and carry the object at the same level.
- When cutting, support stock at a comfortable level. Use sawhorses if necessary.
- Avoid working in awkward or twisted positions.

KNEES

Knee problems are an occupational hazard for all workers who must kneel as they do their jobs. Common disorders are bursitis (inflammation of the bursa, sacs that cushion joints) and fluid buildup on the knee. To minimize risk of knee injury, follow these guidelines:

- Always wear protective knee pads.
- Never use your knees as backing. For example, when nailing a brace to a stake, don't use your knee to steady the stake.

Personal Protective Equipment

For additional information, refer to OSHA regulations 1910.94, 1910.95, 1910.134, 1926.52, 1926.100-1926.104, and 1926.501.

Construction workers wear a variety of special clothing and gear on the job to work safely and prevent injury. Training is required to be sure equipment is used properly.

PROTECTING THE HEAD AND FACE

A hardhat provides construction workers the most basic protection for the head. In any work environment in which falling objects are a possibility—however remote—a hardhat is indispensable.

Additionally, note the following:

- A hardhat can be either uninsulated or insulated. An insulated hardhat protects against electrical shock.
- An orange hardhat identifies the safety monitor on a construction site.

PROTECTING EYES

Eye protection is needed for most construction tasks. On the job, wear eye protection appropriate to the task. The following chart shows safety eyewear for selected jobs:

See Table E-1 in OSHA 1926.102 for more details about safety eyewear.

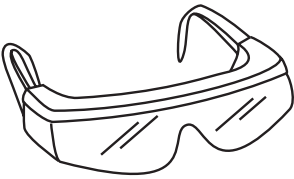
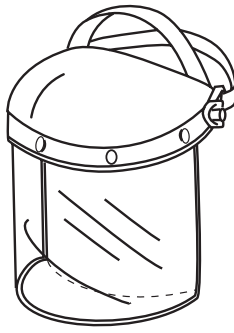
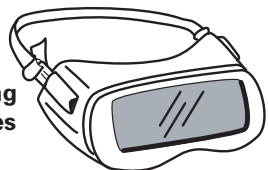
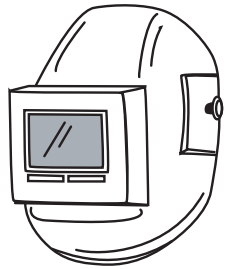
| Sanding, Sawing | Machining | Welding |
|---|---|---|
|  <p>Goggles</p>  <p>Glasses</p> |  <p>Face Shield with Plastic Screening</p> |  <p>Welding Goggles</p>  <p>Welding Helmet with Eye Protection Under It</p> |

(Continued on next page)

NOTES

PROTECTING HEARING

Loud noise can cause irreversible hearing loss. The effect is intensified by the duration (length of time) of the noise. Noise is measured in decibels (dB).

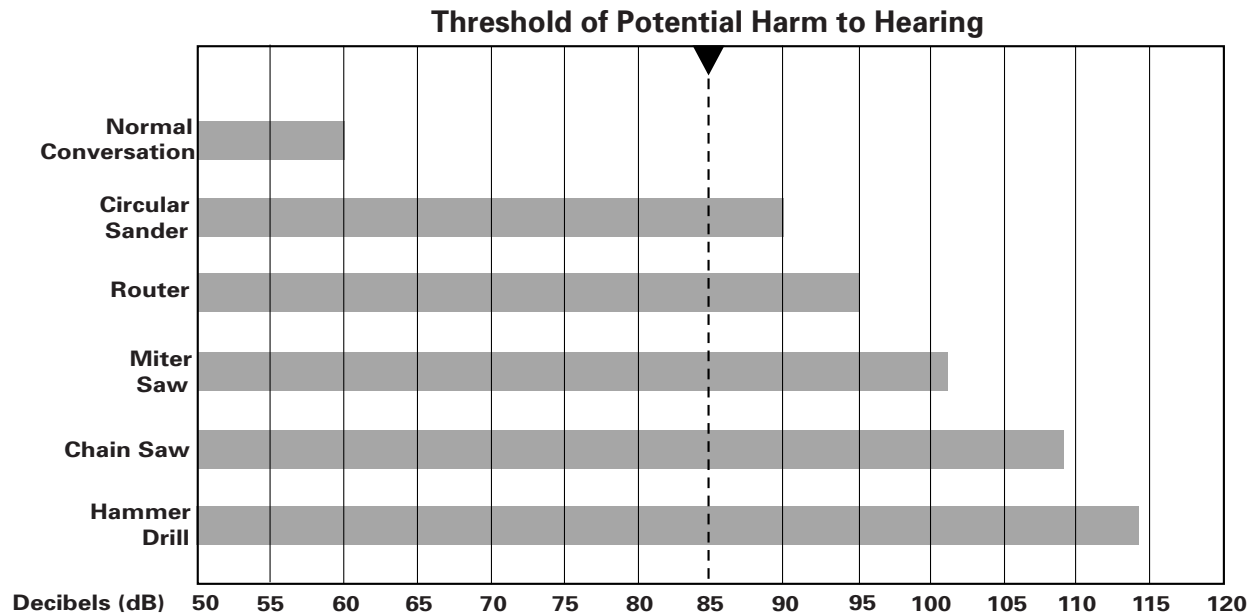

To preserve your hearing, **always** wear earplugs or acoustic earmuffs when working with any noisy tool. Earplugs fit inside the ear; earmuffs cover the ears. Generally speaking, earmuffs provide the most protection. For noise levels over 100 dB, both should be worn.

PROTECTING THE RESPIRATORY SYSTEM

A *dust mask* is a simple protective covering over the lower part of the face. It filters out relatively large particles, such as dust from sanding, and does not require a filter cartridge.

A *respirator* is a facepiece, hood, or helmet designed to protect against harmful airborne agents. "Respirator" usually means face gear with a replaceable filter cartridge. A medical exam is needed before using a respirator. Follow these guidelines for using respirators:

- Use a respirator when work may expose you to fumes, oxygen deficiency, or particulates that a dust mask cannot filter.
- Use a certified respirator with a cartridge designed for the particular contaminate. Certified respirators carry the term NIOSH on their label. The manufacturer's name and type of cartridge are also indicated on the label.
- Before beginning the work, do a fit test of the respirator. The required procedures are given in Appendices A and B-1 of OSHA regulation 1910.134.

Protection from the Environment

For additional information, refer to OSHA regulation 1910.151.

NOTES

On many construction jobs, workers face challenges from heat, cold, and the sun's ultraviolet (UV) radiation.

HEAT HAZARD

Probably the most serious threat to construction workers from the natural environment is heat. Heat can build up to dangerous levels in closed-in, uninsulated spaces and on surfaces exposed to full sunshine, such as roofs.

Conditions that may develop as a result of too much heat are heat cramps, heat exhaustion, and heat stroke. A detailed table describing symptoms and first-aid treatment for these heat-related conditions is given in Safety Sheet 1-6 of this guidebook.

Heat cramps are painful muscle spasms caused by the body's loss of salt through sweating. Symptoms of *heat exhaustion* include extreme weakness, nausea, and headache. Persons with either of these conditions should rest in a cool place and drink small amounts of water or sports drink.

Heat stroke is the most dangerous hazard for people who work in hot places. The body of a victim of heat stroke can no longer regulate its core temperature, which can rise rapidly to 106°F [41.1°C] or higher. (Normal is considered to be 98.6°F [37.0°C].) The person may suffer mental confusion or delirium and may lose consciousness. Heat stroke can cause death. It requires **immediate** medical attention.

Follow these general guidelines to avoid overheating:

- If possible, limit your exposure to heat when you're just starting the job. Increase your exposure gradually so that your body can get used to the heat.
- Wear suitable lightweight clothing.
- Use portable fans when working indoors.
- Drink plenty of water—as much as a quart per hour.
- Alternate work with rest periods in a cool place.
- Schedule heavy work in the cooler parts of the day.

(Continued on next page)

NOTES

COLD HAZARD

In some climates and at certain times of the year, cold can pose a hazard to construction workers, causing hypothermia or frostbite. *Hypothermia* is the most dangerous hazard confronting people who work in the cold. In hypothermia, the body is no longer able to maintain normal body temperature. This condition requires **immediate** medical attention. The table below describes cold-related conditions. (For more information, see Safety Sheet 1-6.)

| Condition | Symptoms | Treatment |
|--------------------|--|---|
| Hypothermia | Shivering, confusion, slurred speech, irrational behavior | Seek immediate medical help; wrap victim in blankets and keep warm. |
| Frostbite | Freezing of exposed skin, especially of the ears, fingers, toes, cheeks, and nose; tingling, stinging, or aching of affected area, followed by numbness; skin appears white and is cold to the touch | Shelter or remove victim from exposure to cold winds and seek immediate medical help. |

Follow these general guidelines to prevent overchilling:

- When evaluating cold, take windchill into account. Wind on exposed skin has the same effect as a lower still-air temperature. For example, a temperature of 30°F (-1°C) would feel like 17°F (-8°C) if the wind blows at 20 miles per hour. The U.S. Weather Bureau issues windchill data in wintertime weather forecasts.
- Pay special attention to protecting feet, hands, ears, face, and head. Use thermal socks and gloves. Wear insulated hats, earmuffs, and hoods. In extreme cold, wear a thermal mask.
- Wear multiple layers of clothing to insulate the body.
- Take frequent breaks in a warm place.

ULTRAVIOLET (UV) RADIATION HAZARD

UV radiation in sunlight poses dangers to people who work outside. It can damage eyesight and cause skin cancer. One type of skin cancer, called melanoma, can be deadly. People with fair skin are at higher risk than others. Follow these guidelines to minimize exposure to UV radiation:

- Limit direct sun exposure.
- Wear UV-blocking glasses or goggles.
- Cover up. Wear clothing that does not transmit visible light.
- Wear a broad-brimmed hat to protect face, ears, and neck.
- Use sunscreen with a protection factor of 15 or higher.

Keeping the Worksite Safe

No Way Out.....32

3-1 Housekeeping, Illumination, Sanitation.....33

3-2 Electrical Safety.....35

3-3 Fire Protection and Prevention39

3-4 Hazardous Materials Identification.....43

3-5 Safety Color Codes.....45

3-6 Accident Prevention Tags.....46

3-7 Confined Spaces.....47

3-8 Excavations49

3-9 Barricades.....53

3-10 Demolition of Structures.....54

No Way Out

A laborer was working in a trench 4' wide and 7' deep. About 30' away a backhoe was straddling the trench. When the backhoe operator noticed a large chunk of dirt falling from the side wall behind the worker in the trench, he called out a warning. Before the worker could climb out, 6' to 8' of the trench wall had collapsed on him and covered his body up to his neck. He suffocated before the backhoe operator could dig him out.

- There were no exit ladders in the trench.
- No sloping or shoring had been done to keep the trench from caving in.
- There was no safety monitor on the worksite.
- No safety and health program was in effect.
- The worksite was not inspected regularly.
- Training and education were inadequate.

Employers must teach workers how to recognize and avoid unsafe conditions. Because the trench was more than 5' deep, its sides should have been supported. Any trench more than 4' deep should have a means of exit, such as a ladder or steps.

Be alert to hazardous conditions at the worksite.

Accidents such as this one could be avoided by following OSHA regulations 1926.21 (safety training and education) as well as 1926.651 and 1926.652 (excavations).

Housekeeping, Illumination, Sanitation

For additional information, refer to OSHA regulations 1926.25, 1926.26, 1926.51, and 1926.56.

NOTES

Employers must provide safe and sanitary working conditions that conform to OSHA's standards. All employees are responsible for maintaining the worksite.

HOUSEKEEPING

- Keep walkways, stairways, storage areas, and work surfaces clear of tools, materials, debris, and clutter.
- Whenever you see nails protruding from work surfaces, walkways, or form and scrap material, remove them or bend them down immediately.
- Remove nails and fasteners when opening crates and cartons or when stripping forms.
- Dispose of scraps and rubbish daily.
- Put oily rags and other highly flammable (able to catch fire easily) waste in approved containers.
- Dispose of hazardous wastes in approved containers with covers.
- Keep walkways and work surfaces dry and free from grease and oil.
- Remove oil, grease, and other liquid spills at once, or cover them with sand or other absorbent material until they can be cleaned up.
- When working above other people, place tools and materials where they will not fall and cause injuries.
- Do not throw materials, waste, or tools from buildings.
- Remove or flag objects protruding at head height.

ILLUMINATION

- Make certain that all construction areas, aisles, stairways, ramps, and storage areas where work is in progress are either naturally or artificially illuminated.
- Report or replace burned out lightbulbs.

(Continued on next page)

NOTES

SANITATION

- There must be potable (suitable for drinking) water available. Containers must be clearly marked as drinking water and must be equipped with a tap.
- Non-potable water (to be used for industrial or firefighting purposes) must be clearly marked.
- Toilet facilities must be available at all worksites and must be kept clean and sanitary.
- Washing facilities must be available and kept sanitary for employees who apply paints, herbicides or insecticides, or other harmful contaminants.
- Lavatories with hot and cold or tepid running water must be available at all worksites.
- Hand soaps or other cleaning agents must be provided.
- Individual cloth or paper hand towels, warm air blowers, or clean continuous cloth toweling must be provided near lavatories.
- If showers are required, they shall be provided for employees, with hot and cold running water, body soap, and individual clean towels.
- Changing rooms must be provided if standards require employees to wear protective clothing because of possible exposure to toxic materials. Storage facilities for street clothes and protective clothing must be separate.
- Eating and drinking areas shall not be near toilet areas or areas exposed to toxic materials.
- Enclosed workplaces shall be built to prevent rodents, insects, and other vermin from entering. If necessary, an extermination program shall be used.



Electrical Safety

For additional information, refer to OSHA regulation 1926.400.

NOTES

Electricity poses hazards on the worksite. Understanding the characteristics of electricity will help you avoid them.

CHARACTERISTICS OF ELECTRICITY

- *Current* is the flow of electric charge. The rate of the flow is measured in amperes (amps).
- *Voltage* is the electrical force that causes the current to flow in a circuit.
- *Resistance* is anything that causes opposition to, or slows down, the flow of the current.

It is the current, or amperage, moving through the body that causes electrical shock, not the voltage. Even 1- to 2-ampere shocks can be fatal, depending on resistance factors, such as wetness of the skin, duration of the contact (which is why it's important to separate a person from the source of electricity), and whether the person is well grounded. Remember that even household current (120 volts) can produce dangerous shock if other factors are in play. See Safety Sheet 1-6 for more information on electrical shock.

POWER LINES

Both underground and overhead power lines can pose hazards on construction sites. Many states now use 811 as the phone number that enables users to reach a "call before you dig" center. The location of utility lines will be marked for no charge.

UNDERGROUND LINES

- The local utility company should be contacted to locate and mark underground lines. Signs should be posted to show these locations.
- If you must use tools, such as a jackhammer or hand tools, in an area where underground lines have not been located, your employer must provide you with insulated gloves.

(Continued on next page)

NOTES

OVERHEAD LINES

Contact with overhead power lines is the most common cause of electrocutions on construction sites.

- Before work begins, the employer should contact the local utility company to identify and insulate, turn off, or de-energize overhead power lines. If this isn't possible, stay at least 10' away from the lines. If the voltage is over 50,000, keep 35' away.
- Equipment such as backhoes and cranes must have signals to warn operators when the machine is getting too near overhead power lines.
- Do not use metal ladders or wooden ladders that are damp or wet near power lines.
- Be careful when lifting long pieces of material, such as siding, by hand when under power lines.
- If equipment comes into contact with a power line, stay on the equipment until the utility company shuts down the line and the power is off.
- If you must leave the equipment, jump clear so that no part of your body is touching the equipment at the same time you are touching the ground. Keep your feet together, landing on both at the same time.

POWER SUPPLIES AND EQUIPMENT ON SITE

- All electrical conductors and equipment (electric panels, circuit breakers, fuses) shall be installed and maintained by an electrician or a *qualified* person.
- The employer must ensure that electrical equipment is free from recognized hazards likely to cause death or serious injury. Many factors, such as voltage, current capacity, mechanical strength, and insulation, must be considered to determine whether equipment is safe. All equipment should be used according to the instructions.
- There must be enough clear working space—at least 3' from live equipment—to allow equipment to be operated safely.
- Live parts of electrical equipment must be in enclosures (cabinets or separate rooms) or within barricades or at least 8' high. High-voltage equipment (over 600 volts) must be in an area open only to *qualified* persons.
- All electrical equipment, tools, and machinery must be clearly labeled. A way to disconnect the power also must be clearly labeled.

(Continued on next page)

- Ground-fault circuit interrupters (GFCIs) must be provided for all permanent wiring and for all temporary 120-volt, 15- and 20-ampere receptacle outlets used during the construction process. They act as circuit breakers to protect against electrical shock, particularly in areas with moisture.

LOCKOUT/TAGOUT

Lockout/tagout is an OSHA procedure required in all workplaces. This procedure is designed to prevent electrical equipment and other hazardous energy sources from being started while being repaired or maintained, and potentially injuring or killing employees. With lockout/tagout, all of the energy sources must be turned off or disconnected, and the energy-isolating devices (such as circuit breakers or disconnect switches) must be locked out if possible and/or labeled with a warning tag.

Only *authorized* persons may perform the lockout/tagout procedure. The procedure must follow these steps:

- Prepare for shutdown.
- Shut down the equipment.
- Isolate the equipment from the energy source.
- Apply the lockout/tagout device(s) to the energy-isolating device. OSHA recommends using durable locks and tags that indicate the identity of the employee using them.
- Safely release all potentially hazardous stored or residual energy.
- Verify the isolation of the equipment prior to beginning service or maintenance work.

OSHA orders the following steps to be taken when work is completed and the equipment is ready to be re-energized:

- Verify that the equipment is intact and working properly.
- Keep all employees safely away from the equipment.
- Ensure that lockout/tagout devices are removed from each energy-isolating device *by the employee who applied the device*.

POWER TOOLS

- Make sure all power tools, extension cords, and other equipment you'll be using are in good working condition by checking cords and plugs.
- All power tools and equipment should be grounded with 3-prong plugs or be double insulated. Never remove the ground pin or use an ungrounded 2-prong adapter.

NOTES

(Continued on next page)

NOTES

- Double-insulated tools have two prongs and do not need an adapter. Make sure the plastic casing is not cracked or broken.
- When you unplug a tool, do not pull on the cord. Pull the plug directly from the outlet.
- Keep cords out of walkways and working spaces.
- Do not fasten extension cords with staples, hang them from nails, or suspend them by wire.

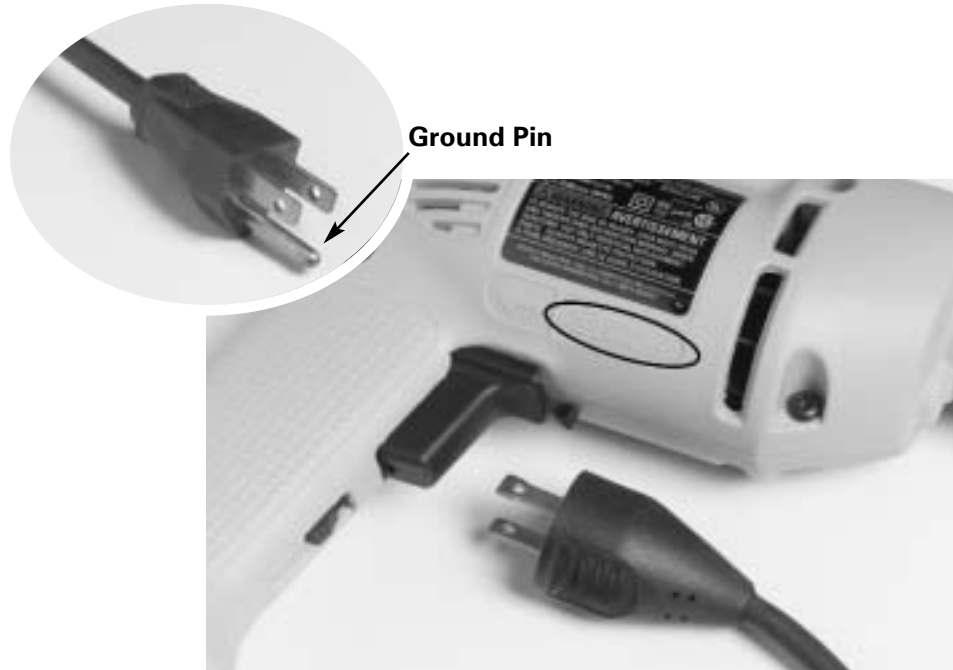
3-Prong Plug**Double-insulated Tool**

The National Electric Code (NEC) was developed by the National Fire Prevention Association to provide “practical safeguarding of persons and property from hazards arising from the use of electricity.” The NEC establishes safety codes for installing electrical equipment in public and private buildings and other structures, and must be followed in all construction projects.

Fire Protection and Prevention

For additional information, refer to OSHA regulations 1926.24 and 1926.150.

Your employer is required by OSHA to develop an effective fire prevention and protection plan and to ensure that fire protection and suppression equipment, such as fire extinguishers or water and hoses, are available and easily located at all times.

PREVENTING FIRES

Because there are so many kinds of combustible materials at a construction site, all employees must assist in keeping the area free of potential fire hazards. To prevent fires:

- Install and maintain electrical wiring and equipment properly.
- Keep the area cleared of weeds and grass.
- Dispose of scraps and rubbish daily. Oily rags and other flammable waste materials must be kept in separate approved containers.
- Store materials properly. Materials such as lumber must be stored in neat, solid piles.
- Flammable liquids must be stored in approved, closed containers.

Closed containers, as OSHA defines them, are sealed with a lid or other device so that neither liquid nor vapor can escape at ordinary temperatures. Flammable liquids must never be stored in exit areas, stairways, or other passageways.



NOTES

(Continued on next page)

NOTES

- Clean up flammable liquid spills or leaks promptly and safely.
- Do not smoke near flammable materials of any kind.

FIGHTING FIRES

The three elements that must come together to start a fire, or to cause combustion, are:

- Oxygen (in the air and in some fuel materials).
- Heat (open flames, sunlight, hot surfaces, sparks and arcs, friction, electrical energy, compression of gases).
- Fuel (gases, such as propane, acetylene, and carbon monoxide; liquids, such as gasoline, turpentine, and paint; and solids, such as wood, paper, grease, plastic, and dust).





Fires are classified by the material that is burning. You must determine the class of a fire to know how to extinguish it.





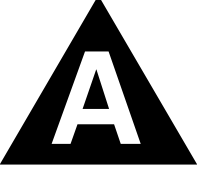

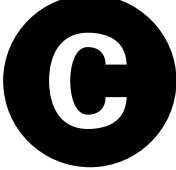



- *Class A*: Ordinary combustibles, such as wood, rags, rubber, and plastics.
- *Class B*: Flammable liquids, such as gasoline, oil, grease, paint, and thinners.
- *Class C*: Electrical equipment, such as motors, switches, and electrical wiring.
- *Class D*: Combustible metals, such as iron, magnesium, sodium, and potassium.

Labels for these classifications are distinctive by letter, shape, and color. The labels appear on fire extinguishers to identify which types of fire they'll effectively extinguish.



(Continued on next page)

| Labels for Fire Extinguishers | | | |
|--|--|---|--|
| Green  Ordinary Combustibles | Red  Flammable Liquids | Blue  Electrical Equipment | Yellow  Combustible Metals |

| Types of Fire Extinguishers | | | | | |
|---|--|---|--|---|---|
| Carbon Dioxide | Pump Tank (Plain Water) | Multipurpose Dry Chemical | Ordinary Dry Chemical | Hallon | Dry Powder |
| |  |  | | | |
|  | |  |  |  | |
|  | |  |  |  | |
| | | | | |  |

NOTES

(Continued on next page)

NOTES

If fire extinguishers are provided, your employer is required by OSHA to train some employees in how to use them properly. If you use a fire extinguisher, make sure you have an unobstructed escape route behind you. Remember the PASS sequence for fighting small fires:

- **P**ull the pin to unlock the fire extinguisher's lever.
- **A**im low, toward the base of the fire.
- **S**queeze the lever to discharge the extinguishing agent.
- **S**weep the hose back and forth across the fire.

EVACUATION

Employers are required to provide emergency action plans to be followed in the event of a fire. The plan should include a way of alerting employees to a fire emergency, such as voice communication or sound signals (bells, whistles, horns) and a way of accounting for the whereabouts of all employees. Every employee must be trained in emergency procedures. Make sure exits are not blocked with materials, equipment, or debris.

The National Fire Protection Association (NFPA) is an international nonprofit organization with a mission to reduce the devastating effects of fire on people's lives by developing codes and standards, research, and education on fire safety. The kinds of sprinkler systems and emergency exits seen in buildings today are the result of the NFPA's recommended codes and standards. Their work has contributed to saving many lives.

Hazardous Materials Identification

For additional information, refer to OSHA regulation 1910.1200.

NOTES

Construction workers are exposed to many hazardous chemical substances. Some, such as flammable materials, pose an immediate potential threat. Others, such as lead, can cause health problems after repeated or prolonged exposure. OSHA developed the Hazard Communication Standard (HCS) to ensure that appropriate information about these substances is provided to employers and employees to protect workers' health. The HCS is also known as the Right-to-Know law.

HAZARD COMMUNICATION

Per OSHA's directives, hazard communication, or HAZCOM, is a threefold process and includes the creation of a Material Safety Data Sheet (MSDS).

First, *manufacturers* must:

- Determine the potential hazards of a substance.
- Include warning labels on containers.
- Prepare an MSDS about the substance.
- Provide the MSDS to employers who will use the substance.

Second, the *employer* must provide:

- A written plan describing how the HCS will be implemented at the worksite.
- The MSDS.
- Training about safe use of substances to employees.

Training may not be limited to simply having employees read the MSDS. The employer must explain the program and how to read an MSDS and must provide employees with the opportunity to ask questions. Training must be repeated if new information about the substance becomes known.

Third, the *employee* must:

- Read and understand the MSDS.
- Use the substance responsibly.

(Continued on next page)

NOTES

MATERIAL SAFETY DATA SHEET

The MSDS must explain any hazards associated with a substance. Every worker must have access to these sheets. Information on an MSDS must include:

- Chemical identity, chemical and common names, and all hazardous ingredients.
- Physical data, such as flash point or boiling point.
- Physical hazards, such as fire and explosion data.
- Health hazards, such as signs and symptoms of exposure and potential medical conditions related to exposure.
- How the substance would enter the body—inhalation (breathing), ingestion (by mouth), or skin contact or absorption.
- Exposure limits—that is, how much contact someone can have with the substance before it becomes harmful.
- Whether the substance is carcinogenic (cancer causing).
- Precautions for safe handling and use.
- Control measures, such as the kinds of personal protective equipment to use.
- Emergency and first-aid measures.
- Revision data—when the MSDS was prepared and the date of the last change.
- How to contact the manufacturer.

(See Safety Sheet 6-3 for information about handling hazardous substances.)

LABELS

Warning labels on hazardous material containers must identify by color and number the hazard level of the material. The label must also identify what personal protective equipment should be worn.

There are several labeling systems. One was developed by the National Fire Protection Association (NFPA). The label consists of squares arranged into a “diamond” shape. Each square has a different color to represent the type of hazard. A number on a square indicates the severity of the hazard. Numbers range from 0 to 4, with 4 representing the greatest hazard. However, any category rated 2 or higher should be considered potentially dangerous.

For example, an NFPA label for toluene would have a 2 in the blue square, a 3 in the red square, and a 0 in the yellow square. Toluene is a chemical used in many paints, paint thinners, lacquers, and adhesives.

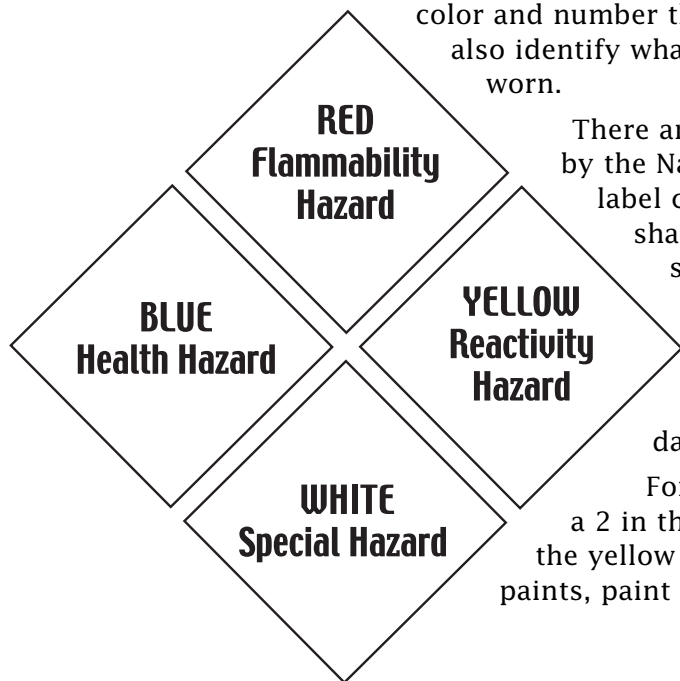

Safety Color Codes

For additional information, refer to OSHA regulation 1926.200.

NOTES

Posted safety signs are designed to protect you and to maintain a safe and healthy workplace. Pay attention to all posted signs. Standard colors are used to identify various hazards as follows.

| Colors for Safety | | |
|--------------------------|----------------------------|---|
| Color | Meaning | Example |
| Red | Danger, stop, or emergency | <ul style="list-style-type: none"> ♦ Fire-protection equipment ♦ Flammable-liquid container ♦ Emergency stop bars and switches |
| Orange | Be on guard | <ul style="list-style-type: none"> ♦ Hazardous parts of equipment or machines that might injure ♦ Safety starter buttons on equipment or machines |
| Yellow | Caution | <ul style="list-style-type: none"> ♦ Physical hazards, such as steps and low beams ♦ Waste containers for combustible materials |
| White | Storage | <ul style="list-style-type: none"> ♦ Housekeeping equipment |
| Green | First aid | <ul style="list-style-type: none"> ♦ Location of safety equipment, such as first-aid kit |
| Blue | Information or caution | <ul style="list-style-type: none"> ♦ Out-of-order signs on equipment ♦ Cautions against using out-of-order equipment |

Accident Prevention Tags

NOTES

For additional information, refer to OSHA regulation 1926.200.

OSHA states that accident prevention tags must be used as a temporary means of warning employees of existing hazards, such as defective tools or equipment. Tags are to be considered *temporary* signs, be attached to the tool or equipment or to part of a structure, and shall not be used in place of accident prevention signs. Be sure to tag and report to your supervisor any defective tools or equipment.

| Accident Prevention Tags | | |
|--------------------------|---------------|--------------------------|
| Tag Color | Ink Color | Message |
| White | Red | Do Not Operate |
| White | Black and Red | Danger |
| Yellow | Black | Caution |
| White | Black | Out of Order, Do Not Use |



White tag-
White letters
on red square

White tag-
White letters on
red oval with a
black square

Yellow tag-
Yellow letters
on a black
background

White tag-
White letters
on a black
background

Confined Spaces

For additional information, refer to OSHA regulation 1910.146, 1926.21 and NIOSH Alert No. 86-110.

According to OSHA, a *confined or enclosed space* is any space that:

- Has a limited means of entry or exit.
- Is subject to the accumulation of toxic or flammable contaminants or has an oxygen-deficient atmosphere.
- Is large enough that a person can enter and perform work in it.

Examples are storage tanks, ventilation or exhaust ducts, trenches, and open-top spaces more than 4' deep, such as pits, tubs, vaults, or vessels.

TYPES OF CONFINED SPACES

A required confined space that does not contain, and does not have the potential to contain, any hazard that could cause serious injury or death, is designated by OSHA as a *nonpermit-required confined space*.

A space designated as a *permit-required confined space* contains hazards. One or more of the following conditions may exist:

- Contains, or potentially contains, a hazardous atmosphere.
- Contains a material that has the capability to engulf a person entering.
- Potentially could trap or asphyxiate a person.
- Contains any other serious safety or health hazard.

Specifically, potential hazards include:

- Lack of natural ventilation.
- Oxygen-deficient atmosphere.
- Flammable/explosive atmosphere.
- Unexpected release of hazardous energy.
- Limited entry and exit.
- Dangerous concentrations of air contaminants.
- Physical barriers or limitations to movement.
- Instability of stored product.

Entry Permits

In the case of permit-required confined spaces, the additional step of completing an entry permit must be taken. It is only valid if it has

NOTES

(Continued on next page)

NOTES

been signed by the entry supervisor. Only the specified worker may enter the confined space. When work inside the confined space has been completed, all tools and debris should be removed, workers should leave, the space should be closed, and the permit canceled.

NIOSH RECOMMENDATIONS

Although OSHA doesn't have a specific standard for every type of confined space, NIOSH has made recommendations for minimizing hazards as follows:

| | |
|--------------------|--|
| Recognition | Train employees to recognize confined spaces and their hazards. |
| Testing | Before entry, a qualified person should test the confined space for: <ul style="list-style-type: none"> ♦ Oxygen level. ♦ Flammability. ♦ Known or suspected toxic substances. |
| Evaluation | <ul style="list-style-type: none"> ♦ Methods for isolating the space, such as lockout/tagout. ♦ Methods to ventilate the space with fresh, uncontaminated air. ♦ Work procedures, including use of safety lines attached to the worker. ♦ Personal protective equipment, such as a respirator. ♦ Communication system to be used. |
| Monitoring | The confined space should be continuously monitored to determine whether the atmosphere has changed during the course of work. |
| Rescue | <ul style="list-style-type: none"> ♦ Establish procedures before entry and specific to each type of confined space. ♦ A standby person should be stationed at the entry and should be equipped with rescue equipment for the worker and self, including a safety line, respirator, and protective clothing. ♦ Rescue procedures should be practiced on a regular basis. |

Excavations

For additional information, refer to OSHA regulation 1926.650.

Carpenters and other tradespeople must often work around excavations and trenches. Without the proper safety measures, cave-ins can occur. Precautions must also be taken regarding equipment and materials, underground utilities, falling hazards, and air quality.

THE EXCAVATION SITE

Workers are not allowed to enter an excavation site until a *competent* person determines it is safe. This means your employer must select and train someone to be in charge of safety on the site and must empower that person to delay or stop work and make changes. That person must be able to recognize soil types and judge how stable the excavation walls are where you will be working.

Do not depend entirely on someone else for your own safety. Before you begin work in an excavation or trench, check to be sure all needed safety precautions have been taken.

NOTES

General Soil Classifications

| Soil Type | Description | Stability |
|-----------|--|-----------|
| A | Has a high clay content; remains stable even when wet or very dry; hard to break up | High |
| B | Contains gravel, sand, and soft loam but less clay; more easily broken up | Medium |
| C | Has a high sand, gravel, or loam content but little or no clay; may be submerged or very wet | Low |

CAVE-INS

During a cave-in, the soil that forms the walls loosens and collapses. Usually there is no warning, and workers cannot get out of the way fast enough. They may be struck by falling rocks or buried under the dirt. If they cannot be rescued in time, they will suffocate.

(Continued on next page)

NOTES

To prevent cave-ins, any excavation or trench over 5' deep must be sloped, benched, or supported. A *slope* is a gentle angle. Loose soil is piled up so it doesn't have far to fall and doesn't fall in large amounts. *Benching* means to form the soil into steps. If a vertical section collapses, it does not fall far and does not trigger a cave-in of the entire wall. *Shoring, bracing, and underpinning* include the use of timbers or other structures to support the excavation walls.

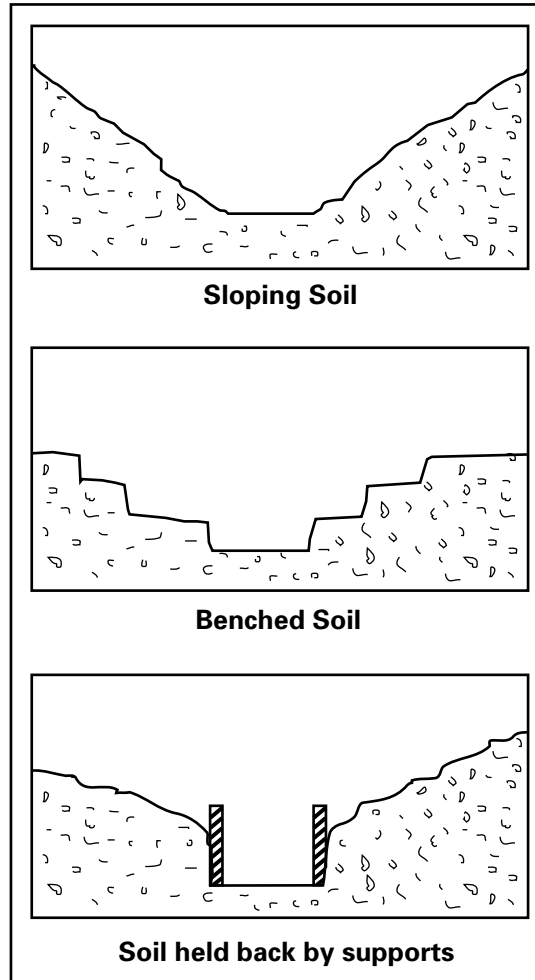

Three kinds of excavations.

WHAT YOU CAN DO

- If the excavation is more than 4' deep, be sure a stair, ladder, ramp, or other means of getting out is within 25' of where you are working.
- If any loose rocks that could hit workers are present, be sure they are blocked.

(Continued on next page)

- Water can cause unstable soil. Standing water must be pumped out of an excavation. Don't work where water is accumulating unless shoring is in place to prevent cave-ins. Be sure the excavation is inspected after every rainstorm.
- Heavy equipment causes vibrations within the soil that can lead to cave-ins. Be sure that such equipment is not operated near an excavation while workers are inside.
- Check to be sure that buildings, sidewalks, and roadways adjoining the excavation are supported to ensure their stability.
- Learn to recognize the signs that a cave-in is likely to occur. Report any danger signs to your supervisor immediately.

NOTES

Danger Signs of a Cave-In

Notify your supervisor at once if you see...

- ♦ Cracks or fissures in a wall face.
- ♦ Sudden crumbling or slumping of soil from a wall face.
- ♦ Slumping or sinking of soil at the bottom of the excavation.
- ♦ Bulging or heaving of material from the bottom of the excavation.
- ♦ Accumulating water.
- ♦ Indications that a protective system is failing.

EQUIPMENT AND MATERIALS

Any equipment or materials must be located where they pose no danger to workers in the excavation.

- Keep all surface equipment, materials, and piles of earth at least 2' from the edge of the excavation.
- If the operator of mobile equipment does not have a clear view of the edge of the excavation, be sure warnings, such as barricades or signals, are used.
- If you are working near traffic, wear a warning vest or other suitable garment.
- Don't stand under loads being carried by digging or lifting equipment. Stay clear of equipment while it is being operated.

(Continued on next page)

NOTES

AIR QUALITY

Dangerous fumes or a lack of oxygen can exist in landfill areas or where hazardous substances are stored nearby. When working in such areas:

- Be sure the atmosphere is tested before entering an excavation more than 5' deep.
- Obtain respiratory protection or provide for ventilation when the air quality is hazardous.
- If controls are used to reduce contaminants, be sure frequent testing is done to ensure that the atmosphere remains safe.
- Be sure emergency equipment is readily available while work is being done.

UNDERGROUND UTILITIES

Sewers, telephone lines, fuel lines, electric power lines, and water lines may all be located at an excavation site.

- Ask that the approximate location of all underground utilities be identified before work begins.
- Be sure that utilities, especially live power lines and fuel lines, have been removed or supported and protected so that you cannot accidentally contact them.
- If the position of utilities cannot be identified, use detection equipment and proceed to work with **extreme caution**.

Barricades

For additional information, refer to OSHA regulation 1926.202.

NOTES

Barricades (barriers) must be in place to protect workers in many instances on a construction site. They often are used together with safety signs or hand signals to warn people to exercise caution or to stay away from a particular area where hazardous work or conditions are present. The following are examples of where barricades, sometimes guardrails or fences, must be placed:

- The area below scaffolds.
- The area around ladders.
- Around excavations 6' deep or more when not readily seen because of plant growth or other visual barrier.
- Around the edge of a well, pit, shaft, and similar excavation 6' deep or more.
- Areas that contain loose soil or rock that could fall or roll from an excavation face. Protective barricades must be installed at intervals to stop and contain falling material.
- An area where mobile equipment is operated adjacent to an excavation, and the operator does not have a clear and direct view of the edge of the excavation. Hand signals to warn the operator may be used instead of barricades.
- The accessible area within the swing radius of the rear of a rotating crane's superstructure or of a backhoe.
- Areas where workers might be exposed to uninsulated energized conductors of parts of a circuit.
- Areas to which objects can fall. For example, someone working at a higher level could accidentally drop tools or materials.
- The area below a hole in the floor where debris is being dropped without the use of a chute. Barricades must be not less than 42" high and not less than 6' back from the projected edge of the opening above.

Demolition of Structures

NOTES

For additional information, refer to OSHA regulation 1926.850.

Demolishing (tearing down) structures can be particularly hazardous, because you might not always know the condition of original materials.

PREPARING FOR DEMOLITION

Before operations can begin, a *competent* person must make an engineering survey of the structure to determine the condition of framing, floors, and walls, and whether any part of the structure might collapse.

- Shore up or brace all walls and floors if the structure has been damaged by fire, flood, explosion, or some other cause.
- All utilities, such as electricity, gas, sewer, and water lines, must be shut off or capped outside the building before work begins.
- If workers need power or other utilities on the site, lines must be temporarily relocated and protected.
- Hazardous materials, such as chemicals, gases, explosives, or flammable materials, must be tested for, and hazards must be eliminated before work begins.
- Remove all hazards involving broken glass.
- Wall openings that might allow workers to fall must be protected up to a height of approximately 42".
- When debris is to be dropped through holes in the floor (without chutes), the area where the debris falls must be enclosed by barricades at least 42" high. Warning signs must be posted at each level.
- All other floor openings must be covered with material that will support the weight of any load. The material must be properly secured so that it will not move.

DEMOLITION

- Cut holes for dropping materials, if needed.
- Begin demolition of exterior walls and floor construction at the top of the structure and move down.
- Each story must be removed and dropped before removal of the story below begins.



Avoiding Falls

One Wrong Step.....56
4-1 Ladders.....57
4-2 Scaffolds.....61
4-3 Working on Roofs65
4-4 Excavation and Trench Areas.....67



One Wrong Step

Carpenters were setting trusses on the second floor of a house they were building. Below them, on the first floor, was an opening for the basement stairway. While placing a truss in position, one of the carpenters fell through the opening to the concrete basement below. He was fatally injured.

- There was no guardrail or floor cover over the opening for the stairway.
- Training and education had not been provided.
- There was a safety monitor on the site.
- A safety and health program was in effect.
- The worksite was inspected regularly.

Falls are the leading cause of injury on a construction site. Even when a safety monitor is present, everyone at the work-site must be on guard for hazards. Employees must be taught to recognize and avoid unsafe conditions associated with their work.

Learn and follow safety rules.

Accidents such as this one could be avoided by following OSHA regulations 1926.21 (safety training and education) and 1926.500 (fall protection).

Ladders

For additional information, refer to OSHA regulation 1926.1050.

NOTES

Construction workers often use ladders for accessing and working in places above surface levels. For this reason, care must be taken to avoid accidents.

CHOOSING THE PROPER LADDER

Choose the proper ladder for the job. It must be strong enough to carry your weight plus the weight of the tools and materials you're carrying. See the table below. Ratings refer to the *maximum intended load*. Most ladders should be able to hold at least four times their maximum intended load (3.3 times for Type IA metal and plastic ladders). Types IA and I are the only acceptable ladders for a construction worksite.

| Grades of Ladders | | |
|---------------------|---------------------|---|
| Type | Duty Ratings (lbs.) | Typical Use |
| Industrial, Type IA | 300 | Extra-heavy duty. For rugged industrial and construction use. |
| Industrial, Type I | 250 | Heavy duty. For contractors and maintenance workers. |
| Commercial, Type II | 225 | Medium duty. For painters and light-construction workers. |
| Household, Type III | 200 | Light duty. For household use. |

INSPECTION AND MAINTENANCE

- Always check the manufacturer's manual or the sticker on the side of the ladder for special safety instructions.
- Inspect ladders carefully. Look for broken rungs, split side rails, and splinters. Keep all fasteners tight.

(Continued on next page)

NOTES

- Tagout damaged or defective ladders and report it to your supervisor. Do not try to repair a ladder yourself. It should be repaired professionally or replaced.
- Make sure the ladder has nonslip safety feet.
- Keep steps and rungs free of oil, grease, paint, and other slippery substances.
- Do not use a ladder that has been water-soaked for a long time or that has been exposed to fire, chemicals, or fumes. These factors could affect the ladder's strength.
- Do not use metal, metal-reinforced, or wet ladders where you might come in contact with live power.
- When you do use a metal ladder, make sure the steps or rungs are grooved or roughened, coated with skid-resistant materials, or otherwise treated to minimize slipping.
- Never paint a wooden ladder. Paint will hide cracks or other damage.

SAFE PLACEMENT

- Always lift ladders from the center and carry them horizontally. Never carry a ladder in an upright position, to ensure that you don't run into power lines or other objects.
- Ladders should always be placed on a firm, level surface.
- Ladders should rest against a firm, flat support surface.
- Do not use ladders on ice or snow unless it's absolutely necessary. Use spike or spur safety shoes on the ladder feet. Be sure they grip properly before you climb.
- Never place a ladder in front of a door or other opening unless the ladder is secured or barricaded.
- Keep the area around the top and bottom of the ladder clear.
- Always place the ladder close to your work so you won't need to overreach or lean out from the ladder. Climb down and move the ladder if necessary.

SAFE USE

- Make sure your boots or shoes are free of mud and slippery substances before you climb a ladder.
- Do not use a ladder as a scaffolding plank.
- Only one person at a time should be on a ladder, unless it's designed for two people.
- Always face the ladder when climbing up or down.
- Keep your weight centered between the side rails.
- When going up or down, grip the rails firmly and place your feet squarely on the rungs.
- Maintain three points of contact at all times when climbing (that is, two feet and one hand or two hands and one foot).

(Continued on next page)

- Carry nothing in your hands while climbing.
- Never move a ladder while it's occupied.
- Never try to move a ladder you're using by rocking it away from the support.
- Do not use a ladder when it's windy.

NOTES

FOLDING LADDERS

- Make sure all four feet are firmly on the ground.
- The ladder must be fully open and the spreader must be locked.
- Make sure all locking devices are secure.
- Never step on the stabilizing bars (the horizontal bars between the back rails) of a stepladder. They are not designed for load bearing.
- Never step on the top step.
- Do not straddle the front and back of a stepladder.
- Never lay tools on the top step.

STRAIGHT LADDERS

- Store horizontally in a dry, ventilated place.
- Make sure the working length of the ladder will reach the height required for support. The ladder should extend at least 3' above the elevation you need to reach.
- Never stand on the top three rungs.
- The foot of the ladder should be a distance equal to one-fourth its working length from its support. The angle created should be approximately 75°.

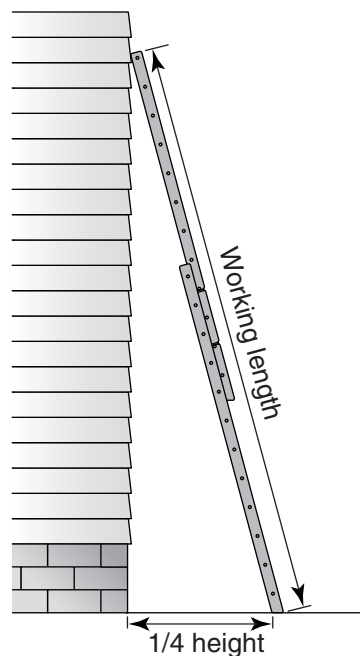

(Continued on next page)

NOTES

- To keep the ladder from slipping when outdoors, drive a strong stake into the ground behind it. Tie the bottom of the ladder to the stake with rope. Another method is to brace it against stakes. A third method is to position the ladders adjustable feet so that they dig into the ground. The pointed portion of each foot should point down.
- Always make sure that both side rails are fully supported at top and bottom.
- Tie the ladder to an immovable object as close as possible to the upper support point to keep it from shifting.
- Never tie or fasten ladders together to create longer sections. Use an extension ladder.
- Be sure all locks on extension ladders are securely hooked over rungs before use.
- Never adjust the height of an extension ladder while you are standing on it.

| Extension-Ladder Overlap | |
|--------------------------------------|----------------|
| Length | Overlap |
| For total extended lengths up to 32' | 3' |
| For total lengths of 32' to 35' | 4' |
| For total lengths of 36' to 47' | 5' |

Scaffolds

For additional information, refer to OSHA regulations 1926.105, 1926.450, and 1926.500.

Scaffolding violations are, according to OSHA, the most cited construction standard. At the worksite, there must always be a *competent* person who inspects scaffolding before each use and trains the workers who erect, disassemble, move, repair, and maintain the scaffolding. A *qualified* person must train workers who use the scaffolding.

Following are general safety standards. However, bear in mind that there are many types of scaffolds and that OSHA has developed specific standards for each.

INSPECTION AND MAINTENANCE

- Always check the manufacturer's manual for special safety instructions.
- Make sure scaffolding is in good condition and has no defects.
- In most cases, platforms must be at least 18" wide, unless the work area is too narrow to accommodate such width. If the platform must be narrower, workers must be protected by guardrails and/or personal fall-arrest systems.
- Lumber used for scaffold planks must be of the proper grade.
- Check connections regularly and tighten those that are loose.
- Scaffolding must be plumb, square, and level.
- Use adjusting screws, not blocks, bricks, or pieces of lumber, to compensate for uneven ground.
- Provide adequate support for scaffolds. Use base plates, making sure that they rest firmly on the ground.
- Make sure mudsills are level and rigid.
- Make sure caster wheels are locked.
- Fasten all braces securely.
- Secure freestanding scaffold towers with guy ropes or wires or by other means.
- Make sure all platforms are fully planked and that planks, if not cleated, extend at least 6" and no more than 12" over the supports.
- Provide proper guardrails if scaffolding is more than 10' above the ground or floor.

NOTES

(Continued on next page)

NOTES

- Provide toe boards to planks when other workers might be below the scaffold.
- Keep tools and materials neat and keep scaffolds and platforms free of debris.

SAFE USE

- Do not overload a scaffold. Make sure the manufacturer's maximum intended load capacity is not exceeded. The maximum intended load is the total weight of all workers, tools, materials, and other loads expected to be on the scaffold. In most cases, scaffolding (and components) must be capable of supporting its own weight and at least four times the maximum intended load.
- Wear slip-resistant boots or shoes and make sure they're free of mud and slippery substances before you climb onto scaffolding.
- Always wear a hardhat when working on a scaffold.
- Never use a ladder as a scaffolding plank.
- Never use a ladder on top of a scaffold.
- Do not climb cross braces. Access to scaffolds must always be by stairs, fixed ladders, ramps, or walkways if platforms are more than 2' above or below a point of access.
- Make sure access to all platforms is safe.
- Never move scaffolding while it's occupied, unless it has been designed specifically to be moved.

FALL PROTECTION

The safety standards mentioned so far are meant to ensure *fall prevention*, that is, to keep workers from falling at all. Even when workers are being extremely careful, accidents can happen. For this reason, *fall protection* standards have been developed. If a worker does fall, he or she will be protected from injury if fall protection standards have been followed.

Workers on scaffolds more than 10' above a lower level must be protected from falling. Fall protection must consist of either guardrails, safety nets, or personal fall-arrest systems. In some cases, a combination is required.

(Continued on next page)

GUARDRAILS AND SAFETY NETS

Guardrails must be installed along all open sides and ends of platforms. These must meet the following specifications:

- The top edge height of top rails must be approximately 42", plus or minus 3".
- Mid-rails must be midway between the scaffold surface and the top rail and must be at least 21" high.
- Guardrail systems must be capable of withstanding a force of at least 200 lbs.
- Guardrail systems must have a surface that will prevent injuries from punctures or lacerations and will prevent snagging of clothes.

Safety nets must be used when the use of guardrails or personal fall-arrest systems is not practical.

- Nets must extend 8' beyond the edge of the work area and as close under the area as practical.
- Mesh size must not exceed 6" by 6".
- Nets must be fastened to supports with forged steel safety hooks or shackles.

Personal Fall-Arrest Systems

These systems stop a fall within a few feet of the worker's original position. Components includes a full-body harness, a shock-absorbing lanyard, a rope grab, a lifeline, and a lifeline anchor. Body belts are **not** acceptable as part of this system.

- Lifelines must be protected against being cut or abraded.
- Connectors must be made of drop-forged, pressed, or formed steel or the equivalent, and must be corrosion resistant.
- Each component must be inspected before each use for any signs of wear, damage, or defects.
- If utilized in a fall, the system must be removed from service immediately to be inspected by a *competent* person.
- Fall-arrest systems must be attached above the person's working position to an anchorage or structural member that can support a minimum dead weight of 5,400 lbs. Never attach a fall-arrest system to a guardrail or hoist.
- Employers must provide prompt rescue if workers fall or must ensure that workers can rescue themselves.

NOTES

(Continued on next page)

NOTES

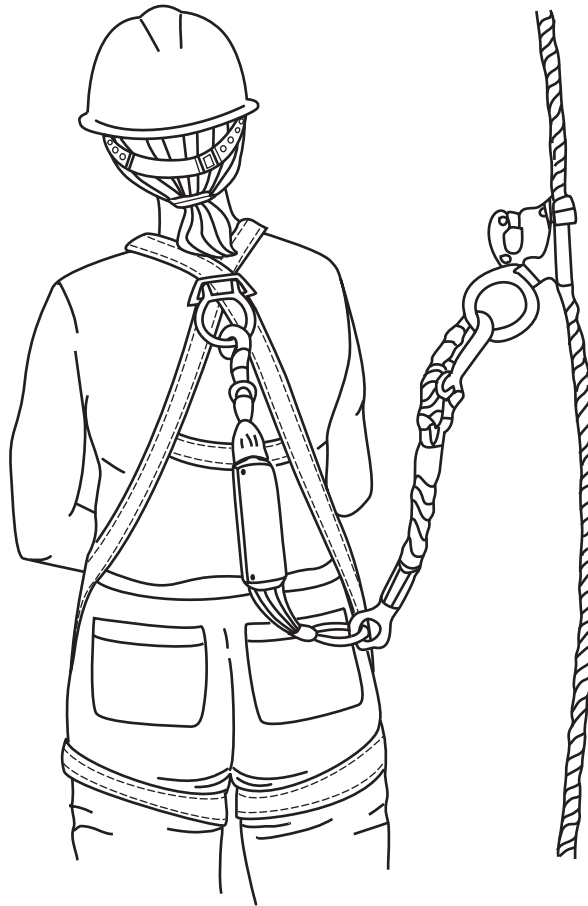

This personal fall-arrest system consists of a body harness attached to a vertical lifeline. In the event of a fall, the stress forces are applied to the shoulders, hips, and legs and not to soft parts of the body, such as the waist, where internal injuries could result. Each worker must be attached to a separate vertical lifeline.

(Continued on next page)



Working on Roofs

For additional information, refer to OSHA regulation 1926.501.

Working at heights above the ground or floor levels can be dangerous. Take every safety precaution and use care and common sense when working on a roof.

PERSONAL PRECAUTIONS

When working on roofs, be sure to take these precautions:

- Make sure the roof surface is free of dew, frost, or other slipping hazards.
- Do not do roofing work during storms, high winds, or other weather conditions that might cause hazards.
- Wear skid-resistant shoes or boots.
- Exercise extreme caution when moving around the roof. Watch your footing and always know where the edges are.
- If you begin to lose your balance, sit down if possible.
- Keep tools and materials in neat piles to avoid tripping.
- Cover skylights and other openings or install guardrails around them.
- Use ladder-safety skills when climbing and descending.

SLIDE GUARDS

Install slide guards on the roof before beginning work. A *slide guard* is a 2×6 set with roof brackets at a 90° angle along the run of the roof. If you slip or start to fall, the slide guard will break your fall.

- When the roof pitch is from 4/12 to 6/12, install slide guards along the eave after the first three rows of roofing material are in place.
- When the roof pitch is more than 6/12, install slide guards along the eave after the first three rows of roofing material are in place and again every 8' up the roof.

NOTES

(Continued on next page)

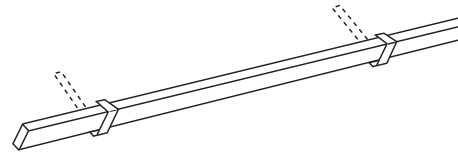
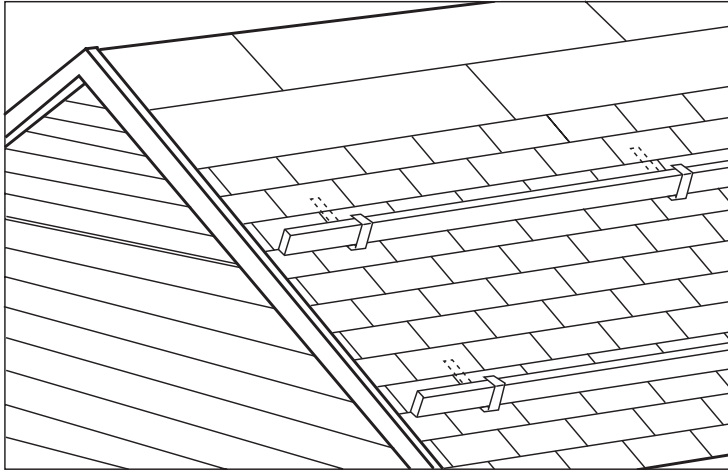

NOTES

FALL PROTECTION

In the event that a worker does fall, he or she must be protected from injury. In residential construction, on roofs with unprotected sides and edges 6' or more above lower levels, whether the roof is low-slope or steep, workers must be protected by:

- Guardrails.
- Safety nets.
- Personal fall-arrest systems.

(See Safety Sheet 4-2 for descriptions and requirements of fall protection systems.)

(Continued on next page)

Excavation and Trench Areas

For additional information, refer to OSHA regulation 1926.500.

When you are working around excavations and trenches, falls are always a hazard unless precautions are taken. Make sure a *competent* person has approved the excavation or trench before you enter the areas around or in the excavation or trench. Also, be sure you are trained by a *competent* person in recognizing and minimizing fall hazards.

WORKING AT GROUND LEVEL

- Make sure the area around the trench is free of tripping hazards.
- Block or barricade any wells, pits, or shafts.
- If you must cross over an excavation or trench as you work, be sure a walkway has been installed. Even if you think you can make it, don't try to jump over it.
- Walkways 6' or more above the excavated level must have guardrails.
- Stay at least 2' from the edge of an excavation. Soil along the edges can collapse from your weight and take you with it.

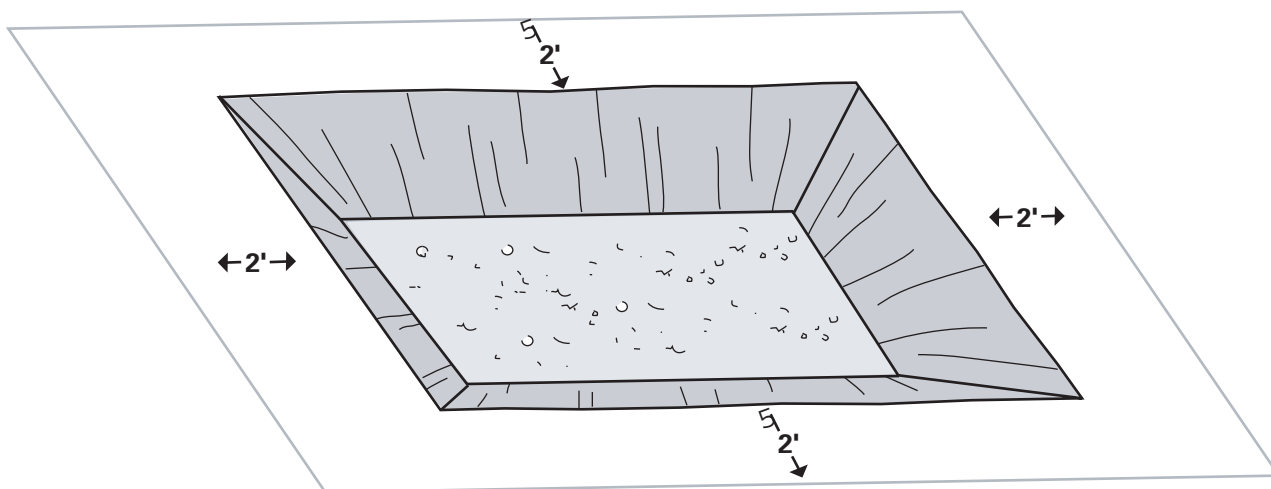

NOTES

(Continued on next page)

NOTES

ENTERING, WORKING WITHIN, AND EXITING

- When entering deep and confined footing excavations, wear a harness with a lifeline securely attached to it. The lifeline must be separate from any line used to handle materials and must be attended by another person at all times while you are wearing it in the excavation.
- Ladders must be secured and extend a minimum of 3' above the landing.
- Do not climb on shoring or bracing.
- Have a lookout standing by the entire time you are working in an excavation or trench.
- Be sure there is a ladder or a ramp within 25' of where you are working in any trench that is 4' or more deep.

GENERAL SAFETY PRECAUTIONS

- Wet soil can be slippery. Don't run or try to carry unwieldy loads if you're not sure of your footing.
- Be sure that any exposed lines, wires, or pipes are clearly marked or covered so they do not cause tripping.
- Wear steel-toed boots or shoes and a hardhat.
- Make sure you have adequate lighting if you are working at night.
- Learn emergency rescue methods, but do not attempt to rescue a fellow worker from an excavation or trench if you are not trained to do so. Many workers are killed while trying to rescue others.

(Continued on next page)

Tool and Equipment Safety

| | |
|---|-----|
| Dangerous Power..... | 70 |
| 5-1 Hand Tools | 71 |
| 5-2 Sawing Tools | 73 |
| 5-3 Edge-Cutting and Shaping Tools | 74 |
| 5-4 Assembly, Fastening, and Disassembly Tools..... | 75 |
| 5-5 Drilling and Boring Tools | 77 |
| 5-6 Wrenches, Pliers, and Snips | 78 |
| 5-7 Electric Tools..... | 79 |
| 5-8 Pneumatic Tools | 80 |
| 5-9 Powered Abrasive Wheel Tools | 81 |
| 5-10 Liquid Fuel Tools..... | 82 |
| 5-11 Hydraulic Tools | 83 |
| 5-12 Powder-Actuated Tools..... | 84 |
| 5-13 Circular Saws..... | 85 |
| 5-14 Table Saws | 87 |
| 5-15 Radial-Arm Saws..... | 89 |
| 5-16 Miter Saws | 90 |
| 5-17 Jigsaws and Reciprocating Saws | 91 |
| 5-18 Electric Drills..... | 92 |
| 5-19 Routers | 93 |
| 5-20 Sanders..... | 94 |
| 5-21 Jointers..... | 95 |
| 5-22 Electric Planers and Planes | 96 |
| 5-23 Plate Joiners | 97 |
| 5-24 Lasers | 98 |
| 5-25 Power Nailers and Staplers | 99 |
| 5-26 Welding Tools and Equipment | 101 |

Dangerous Power

Two men were installing window shutters. One was climbing a metal ladder to hand an electric drill to his coworker, who was on a scaffold about 5' above him. When the man reached the third rung of the ladder, he received an electric shock that killed him.

- An extension cord connected to the drill was missing a grounding prong. A conductor on the green grounding wire was making intermittent contact with the energizing black wire, thereby energizing the entire length of the grounding wire and the drill's frame.
- The drill was not double insulated.
- There was no safety monitor on the site.
- The worksite was not regularly inspected.
- A partial safety and health program was in effect.
- Some training and education had been provided.

All electrical equipment should be properly grounded. It should be inspected daily. If it is damaged or defective, it should not be used until it has been repaired.

Don't take chances with power tools.

Accidents such as this one could be avoided by following OSHA regulation 1926.404 (wiring design and protection).

Hand Tools

For additional information, refer to OSHA regulation 1926.301. See also Technical Links on the OSHA website.

Hand tools include all non-powered tools. The greatest hazards posed by these tools result from carelessness, poor maintenance, or misuse.

SAFETY PREPARATIONS

Prepare Yourself

- Dress appropriately. Don't wear loose clothing or jewelry that could catch on tools, materials, or other items such as nails. Tie back long hair.
- Wear eye protection. Working with most hand tools can create eye hazards under at least some conditions.
- Before using a tool, make sure you understand how to operate it safely.
- Keep all tools in good condition with regular maintenance.

Work Area

- Keep your work area clean and neat.
- Keep flammable materials away from the immediate work area. Work that involves metal on metal, such as using a cold chisel on a rivet or nail, could strike a spark.
- Fasten the workpiece securely in a vise, if appropriate.



NOTES

(Continued on next page)

NOTES

CHECKING THE TOOLS

- Keep tools in good condition. Inspect each tool before you use it.
- Never use a damaged tool such as a wrench with sprung jaws or a hammer with a loose or cracked handle. Obtain a new tool.
- Keep all cutting and sawing tools sharp. A dull tool is more likely to cause accidents than a sharp one.
- Never try to test the sharpness of a tool on hands or fingers. Always use wood or paper.

USING HAND TOOLS SAFELY

- Be careful not to drop a tool. It could hit and injure you.
- When using a tool, keep hands and fingers away from the cutting edge, sharp point, or impact position.
- Be especially careful when using hands or fingers as a guide, as when starting a nail.
- Don't aim the sharp point of a tool at yourself or anyone else.
- Put away tools when finished with them. Out-of-place tools can create hazards for anyone using the work area.
- Use the correct tool for the job. Don't misuse tools. For example, don't use a screwdriver as a chisel. Misusing tools tends to cause accidents.

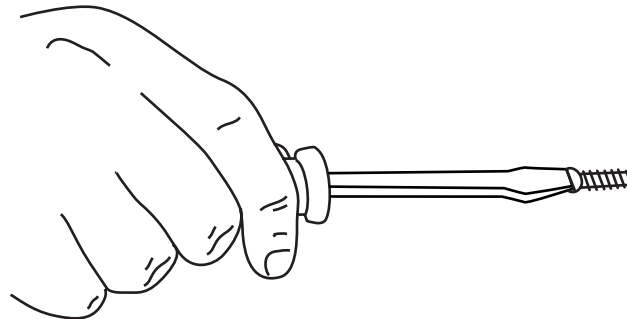

Sawing Tools

For additional information, refer to OSHA regulations 1926.301 and 1926.304.

Different kinds of handsaws are available for a wide range of cutting jobs. Saws commonly used in construction are the backsaw, the crosscut saw, rip saw, hacksaw, keyhole saw, toolbox saw, coping saw, dovetail saw, and the utility drywall saw. Observing safety is mostly a matter of using care and common sense.

SAFETY PREPARATIONS

- Dress appropriately. Don't wear loose clothing or jewelry that could catch on tools or materials. Tie back long hair.
- Wear eye protection. Working with most hand tools can create eye hazards under at least some conditions.
- If the wooden handle of a saw is loose, cracked, or splintered, don't use the tool. Turn it in to the job supervisor.
- Make sure nails and screws are removed from old material before sawing.
- Fasten the workpiece securely in a vise.

SAFE PRACTICES

- Don't drop the saw. It could hit and injure you.
- Never strike the teeth of the blade on a metal surface, such as the edge of a metal vise.
- Keep fingers away from the saw edge while cutting.
- When changing blades on a hacksaw, handle them carefully. Hold a blade by the flat edge rather than the toothed edge. Make sure the new blade is properly secured and the wing nut tightened appropriately.
- Don't aim a saw blade or the sharp point of a saw such as a compass (keyhole) saw at yourself or anyone else.

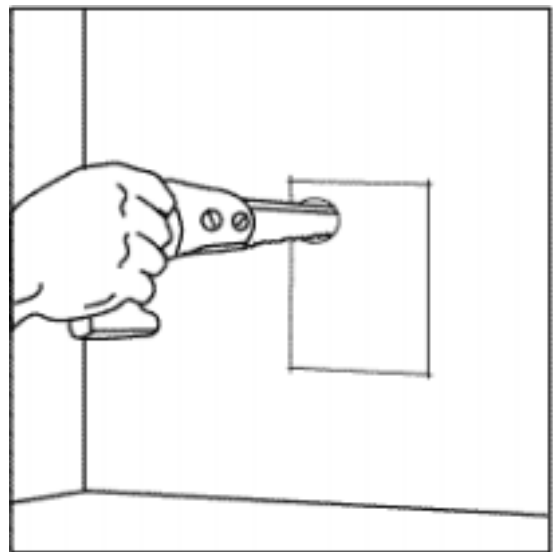

NOTES

Edge-Cutting and Shaping Tools

NOTES

For additional information, refer to OSHA regulations 1926.301. See also Technical Links on the OSHA website.

Edge-cutting and shaping hand tools include planes, chisels, rasps, files, and knives. Many of these tools are sharp and could cause cuts.

SAFETY PREPARATIONS

- Dress appropriately. Don't wear loose clothing or jewelry that could catch on tools or materials. Tie back long hair.
- Wear eye protection.
- Keep flammable materials away from the immediate work area. You could strike a spark while working.
- Fasten the workpiece securely in a clamp or vise.

SAFE PRACTICES

- Keep fingers away from the cutting edge when working.
- Don't drop the tool. It could hit and injure you.
- Use tools only for their intended purposes.
- Never use a rasp or file as a pry bar. It might snap.

PLANES, CHISELS, AND KNIVES

- Make sure the blade is sharp. Using a plane with a dull edge might cause the tool to stick and jam.
- Never plane over metal such as a nail or screw.
- Never grasp the underside of the plane at or near the cutting edge. The blade could cut you.
- Don't try to cut overly thick shavings.
- Keep the edge of a chisel or the blade of a knife sharp.
- After using a utility knife, put the blade in a safe place. Either retract it or take it out of the holder and store it.
- The utility knife used for cutting drywall has a rigid, unretractable blade. Take extra care when storing the knife in a nail pouch.
- Don't use a chisel with mushroomed or damaged head.
- Direct the chisel cut away from your body.
- Use a wood or plastic mallet—never a metal hammer head—to strike the handle of a chisel.
- Never use a chisel to pry open a paint can.

Assembly, Fastening, and Disassembly Tools

For additional information, refer to OSHA regulations 1926.301. See also Technical Links on the OSHA website.

Assembly and *fastening* tools include clamps, vises, hammers, mallets, nail sets, screwdrivers, staplers, and tackers. *Disassembly* tools include pry bars and the pry ends of hammers. Observing safety with these hand tools is a fairly simple matter.

SAFETY PREPARATIONS

- Dress appropriately. Don't wear loose clothing or jewelry that could catch on tools or materials. Tie back long hair.
- Wear eye protection. Working with most hand tools can create eye hazards under at least some conditions.
- Keep flammable materials away from the immediate work area. You could strike a spark while working.
- Fasten the workpiece securely, if necessary.

SAFE PRACTICES

- Be careful not to drop the tool. It could hit and injure you. Be especially cautious with heavy tools such as bar clamps, ripping bars, or hammers.
- Don't aim the sharp end of a tool at yourself or anyone else.
- Don't use a screwdriver as a chisel. Pressure might cause the tool to break and fly off, perhaps hitting someone.
- Never apply force to any stapler or tacker unless it is pressed firmly against a surface you intend to drive the staple into.

HAMMERS

- The most common injury when using a hammer is to miss the nail head and strike a finger. Minimize the danger by following the guidelines below.

NOTES

(Continued on next page)

NOTES

How to Hammer a Nail Safely

When nailing into hardwood, such as oak or maple, drill a small pilot hole. This preparation will make driving in the nail much easier

1. Hold the nail near its head with thumb and forefinger.
2. Watch the nail head, not the hammer.
3. Position the hammer on the nail head, draw the hammer back, and give the nail a few light taps to set its position.
4. Let go of the nail and finish hammering.

- Don't hold nails in your mouth.
- Never use a claw hammer on hardened metal.
- If the wooden handle of a hammer is loose, cracked, or splintered, don't use the tool. Obtain a new one.

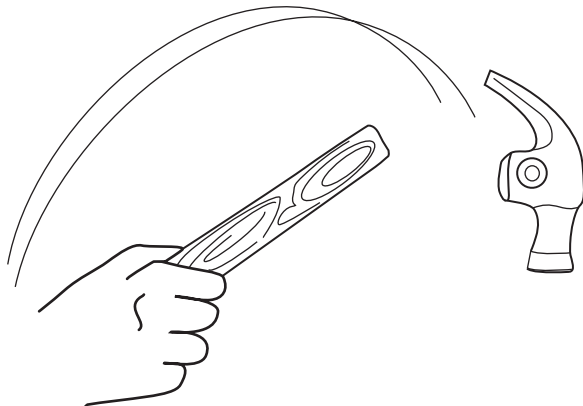

Never use a tool with a loose handle.

CLAMPS AND VISES

- Don't put fingers in the jaws of a clamp or vise when tightening it.
- Position clamped materials out of the way so that you or other workers will not stumble on them.

Drilling and Boring Tools

For additional information, refer to OSHA regulation 1926.301.

Many drill bits used in hand drills and push drills end in sharp points. Exercise care when using them.

SAFETY PREPARATIONS

- Dress appropriately. Don't wear loose clothing or jewelry that could catch on tools or materials. Tie back long hair.
- Wear eye protection.
- Fasten the workpiece securely in a vise or to a bench top. When using a bench, place scrap wood under the workpiece so you won't cut holes in the bench.

SAFE PRACTICES

- Make sure the bit is straight in the chuck and then tighten it in firmly.
- Never carry the drill with the bit in it, and don't point it at anyone.
- Don't apply bending pressure on the bit. Smaller sizes of bits will break easily.
- Be careful not to drop the drill. It could hit and injure you.
- Bits used with the push drill have a diameter approaching that of a needle. Be especially careful with this tool.



Push Drill

NOTES

Wrenches, Pliers, and Snips

NOTES

For additional information, refer to OSHA regulation 1926.301.

Snips as well as many wrenches and pliers have sharp ends or points that can be dangerous if used carelessly. Also, many of these tools have jaws that pivot on a fulcrum. These can inflict pinching or crushing injuries if misused.

SAFETY PREPARATIONS AND PRACTICES

- Dress appropriately. Don't wear loose clothing or jewelry that could catch on tools or materials. Tie back long hair.
- Wear eye protection.
- Be careful not to drop a heavy tool such as a pipe wrench. It could hit and injure you.

WRENCHES AND PLIERS

- Use the appropriate tool for the job. Using a wrench or pliers of the wrong size, for example, could cause the tool to slip while in use.
- Do not use a wrench when the jaws are sprung.
- Do not put fingers in the jaws of a wrench or pliers.

SNIPS

- Make sure the snips are sufficiently sharp. If necessary, test the tool on scrap material.
- Make sure the tool is in good condition. Check to see that handles are not cracked and are fastened tightly.
- Keep hands and fingers away from the sharp edges of the tool.
- Similarly, keep hands and fingers from sharp edges cut by the tool, such as sheet metal.
- When carrying snips, always keep the pointed ends down and away from you. Do not point the tool at anyone.

Electric Tools

For additional information, refer to OSHA regulation 1926.302. See also Technical Links on the OSHA website.

Electrical shock is a potential hazard of using electric tools. Even a small jolt can cause injury or even death. Attention to safety will minimize this danger.

SAFETY PREPARATIONS

- Dress appropriately. Don't wear loose clothing or jewelry that could get caught in a tool. Tie back long hair.
- Wear eye protection. Working with most electric tools can create eye hazards under at least some conditions.
- Before using an electric tool, make sure you understand how to operate it safely.
- Check the manufacturer's manual for any special safety instructions.

ELECTRICAL SAFETY

- Plug the tool into the correct type of socket. Never remove the third prong.
- Never use any electric tool in a damp or wet location.
- If you need to use an extension cord, use one with three-prong plugs and suitable gauge (wire size) and ampere (current) rating for the tool.
- Make certain the tool's switch is in the "off" position before plugging in the power cord.
- Remove all keys and adjusting wrenches from the tool before turning it on. However, keep any safety guards in place and in good working order.
- Never carry a plugged-in tool with your finger on the switch.
- Never use an electric tool that acts or sounds faulty or damaged. Report it to the job supervisor at once.
- Always unplug a tool before making adjustments or changing accessories such as saw blades or drill bits.
- Never yank the cord of an electric tool. Never dangle or carry a tool by the cord.
- Unplug the tool as soon as you finish using it.

NOTES

Pneumatic Tools

NOTES

For additional information, refer to OSHA regulation 1926.302. See also Technical Links on the OSHA website.

Pneumatic tools are powered by compressed air. They can be dangerous if used carelessly. Pneumatic tools include chippers, drills, hammers, sanders, and nailers.

SAFETY PREPARATIONS

- Dress appropriately. Don't wear loose clothing or jewelry that could get caught in a tool. Tie back long hair.
- Wear appropriate eye and hearing protection.
- Before using a pneumatic tool, make sure you understand how to operate it safely.
- Check the manufacturer's manual for any special safety instructions.

SAFE PRACTICES

- Before transporting an air compressor, release the pressure in the air-storage tank. Secure the compressor so it does not roll around in the vehicle.
- If you are using a belt-driven air compressor, make sure the belts are protected by a cover.
- The air hose should have a minimum working-pressure rating that is 50 percent higher than the maximum pressure delivered by the compressor.
- Check the condition of the hose regularly. Never step on the hose, and do not use it to hoist or dangle the tool.
- Point the tool at the ground when you connect a pressurized air hose. Sudden pressure could cause the tool to fire. Make sure the connection is secure.
- Do not operate the tool at a higher pressure than it was designed for. Pressure of the compressed air is indicated in pounds per square inch (psi) on the pressure gauge of the air compressor. Check the gauge periodically.
- Pay particular attention to the hose while using a pneumatic tool on a roof. Secure the hose to a point near the place where you are working.
- Never point a pneumatic tool at anyone.

Powered Abrasive Wheel Tools

For additional information, refer to OSHA regulation 1926.303. See also Technical Links on the OSHA website.

NOTES

Finish carpenters use abrasive wheel tools to sharpen chisels, planes, and scrapers. Observe the following safety rules when using abrasive wheels.

SAFETY PREPARATIONS

- Dress appropriately. Don't wear loose clothing or jewelry that could get caught in the wheel. Tie long hair back.
- Wear appropriate eye and hearing protection.
- Check the manufacturer's manual for any special safety instructions.
- Keep flammable materials away from the work area. A spark struck on the abrasive wheel could ignite them.

SAFE PRACTICES

- Make sure the tool is in good working condition. Test the wheel (before turning on the power) by tapping it gently with a light non-metallic instrument. If the tap produces a ringing sound, the wheel is solid; if a dead sound results, the wheel may contain a flaw. If you suspect the wheel has a crack or other flaw, do not turn on the power. Change the wheel and turn in the damaged wheel to the site supervisor.
- Unplug the machine to change wheels. Make sure the new wheel is properly mounted on the spindle and tighten the spindle nut appropriately.
- Do not stand directly in front of the wheel as it accelerates after power-up. Wait until it has reached full operating speed.
- Firmly grip the tool as you sharpen it.
- Turn the power off when leaving the work area.

Liquid Fuel Tools

NOTES

For additional information, refer to OSHA regulation 1926.302.

Some power tools, such as air compressors and chain saws, are fueled with highly combustible liquid fuels such as gasoline. Use of these tools requires special safety precautions.

SAFETY PREPARATIONS

- Dress appropriately. Don't wear loose clothing or jewelry that could get caught in a tool. Tie back long hair.
- Wear eye, face, and/or hearing protection as necessary.
- Before using a fuel-powered tool, make sure you understand how to operate it safely.
- Check the manufacturer's manual for any special safety instructions.

SAFE PRACTICES

- Transport and store fuel only in approved containers for flammable liquid. Keep such containers away from the immediate work area.
- If a liquid fuel spills or leaks, clean it up promptly and safely. Store rags or other flammable materials in separate approved containers.
- Never refuel or service the tool while it is running.
- Shut down an engine and allow it to cool before refueling. Doing so will minimize the danger of igniting vapors.
- Provide adequate ventilation when using the tool in an enclosed area. Gasoline-powered engines give off harmful fumes, including carbon monoxide.
- Never smoke near flammable materials.
- Always keep a fire extinguisher close at hand.
- Do not block exits with materials, equipment, or debris. People must be able to exit quickly in case of fire.

Hydraulic Tools

For additional information, refer to OSHA regulation 1926.305. See also Technical Links on the OSHA website.

Hydraulic tools, such as jacks, make use of the force in pressurized fluids. Hydraulic shoring is sometimes used to support the walls of excavations to prevent cave-ins.

SAFETY PREPARATIONS

- Dress appropriately. Do not wear loose clothing or jewelry that could get caught in the tool. Tie back long hair.
- Wear eye, face, and hearing protection as necessary.
- Before using a hydraulic power tool, make sure you understand how to operate it safely.
- Check the manufacturer's manual for any special safety instructions.

SAFE PRACTICES

- Use hydraulic fluid that is recommended for the tool. By law, hydraulic fluids are required to be fire-resistant.
- Do not exceed the manufacturer's recommended safe operating pressure. Any hoses, valves, pipes, or other fittings must be able to withstand this pressure safely.
- If the tool will be exposed to freezing temperatures, antifreeze must be added to the hydraulic fluid. Consult the operating manual or contact the manufacturer for more information.

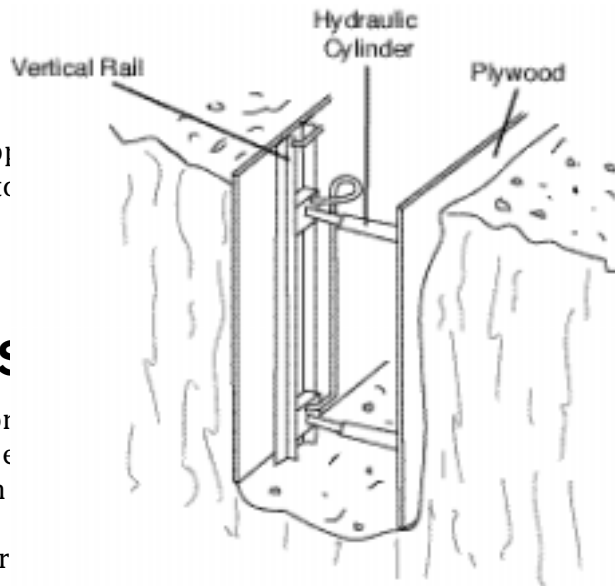

NOTES

Powder-Actuated Tools

NOTES

For additional information, refer to OSHA regulation 1926.302. See also Technical Links on the OSHA website.

Powder-actuated tools are used to install fasteners into steel, concrete, and masonry. They operate like a loaded gun, driving a fastener (rather than a bullet) forward at great speed. *These tools **must** be used only by employees certified in their proper use.*

SAFETY PREPARATIONS

- Dress appropriately. Don't wear loose clothing or jewelry that could get caught in a tool. Tie back long hair.
- Wear appropriate eye, hearing, and face protection.
- Check the manufacturer's manual for any special safety instructions.

SAFE PRACTICES

- Select a powder level that is right for the tool and able to do the work without excessive force.
- If a powder-actuated tool misfires, hold it in the operating position for at least 30 seconds before trying to fire again. If the tool still does not fire, hold it in the operating position for 30 seconds more before removing the cartridge according to manufacturer's instructions. Immerse the cartridge in water immediately.
- Do not load the tool unless it is to be used immediately.
- Do not leave a loaded tool unattended, especially where it might be found by someone not trained in its use.
- Never point the tool at anyone.
- Do not fire fasteners into a material that they might pass completely through.
- Do not drive fasteners into very hard or brittle material that might chip or splatter or make the fasteners ricochet (bounce).
- If a tool is not in proper working order or develops a defect during use, turn it in at once to the job supervisor.

Circular Saws

For additional information, refer to OSHA regulation 1926.304.

NOTES

One of the most important tools on any job site is the portable circular saw. It is used for many tasks and can cut a variety of materials. Kickback is a major safety concern when using a circular saw.

SAFETY PREPARATIONS

- Dress appropriately. Don't wear loose clothing or jewelry that could get caught in the saw blade. Tie back long hair.
- Wear appropriate eye and hearing protection.
- Make sure the teeth of the blade are sharpened correctly and the stock is free of nails.
- Plan to use a respirator if you will be cutting materials that create harmful dust, such as fiber-cement. If possible, connect a vacuum attachment as well.
- Check the manufacturer's manual for any special safety instructions.

SAFE PRACTICES

- Use the correct blade for the work to be done.
- Clamp stock to a work surface if it cannot be held safely.
- Always keep the guard in place and the blade adjusted for the correct depth of cut.
- Allow the saw to reach full speed before starting a cut.
- Always keep your hands clear of the cutting line.
- Never cut while you are off balance.
- Never make an adjustment on a saw while it is running.
- Unplug the saw to change a blade. Make sure the teeth are pointing in the direction of blade rotation and that the arbor nut is tightened properly.
- When finished with a cut, release the switch. Wait until the blade comes to a stop before setting down the saw.

(Continued on next page)

NOTES

KICKBACK HAZARD

Kickback occurs when a spinning blade encounters something that stops it while the saw is under full power. Consequently, the saw is “kicked back” at the operator. In the split second after this occurs, the operator loses control of the saw, and the blade starts spinning again.

Situations Leading to Kickback**Kickback can occur when...**

- ♦ The saw is twisted to the side during the cut or pulled backwards. This causes the blade to bind.
- ♦ The material on one or both sides of the cut bends, pinching the saw blade.
- ♦ The saw encounters a large knot, which suddenly slows the blade.

Avoiding Kickback

The following safe practices will minimize the potential for injury from kickback:

- Always cut in a straight line.
- Always support the wood in a way that prevents the cut pieces from pressing against the blade.
- Always keep a firm grip on the saw.
- Always work with a sharp blade. Dull blades are more likely to bind or stall.
- When cutting through a knot, push the saw through at a slower rate.
- Never stand in a direct line with the blade. This rule protects against kickback and the possibility that a loose piece of wood might be ejected violently from the saw.



Table Saws

For additional information, refer to OSHA regulation 1926.304.

The table saw is a stationary circular saw. The blade protrudes from a slot in the table. Stock is pushed into contact with the blade for cutting. Kickback is a major safety concern when using a table saw.

SAFETY PREPARATIONS

- Dress appropriately. Don't wear loose clothing or jewelry that could get caught in the saw blade. Tie back long hair.
- Wear appropriate eye and hearing protection.
- Make sure the blade is sharp and the stock is free of nails.
- Keep the work area clean and uncluttered.
- Plan to use a respirator if you will be cutting materials that create harmful dust, such as fiber-cement. If possible, connect a vacuum attachment as well.
- Check the manufacturer's manual for any special safety instructions.

SAFE PRACTICES

- Use the correct blade for the work to be done.
- Adjust the blade so it protrudes just enough above the stock to cut completely through. For most cutting, the top of the blade should extend no more than 1/8" above the stock.
- Do not saw warped or bowed material.
- Never stand directly behind the blade.
- Never cut freehand.
- Keep the saw table clean. Remove all scraps with a brush or push stick, never with fingers.
- Always keep the guard and splitter in place. If the cut you are making doesn't permit use of the guard, use a featherboard or special guard.
- Never reach over a spinning saw blade. Instead, reach around the side of the machine.
- Keep fingers away from the saw blade at all times.
- Unplug the saw before changing blades.

NOTES

(Continued on next page)

NOTES

RIPPING AND CROSSCUTTING

A *ripping cut* is made along, or with, the grain of wood, and a *crosscut* is made across it.

- Hold the stock firmly against the rip fence when ripping and against the miter gauge when crosscutting. A coworker may support the stock but should not pull it.
- When ripping, place the jointed edge against the fence.
- When ripping stock that cannot be fed safely by hand, always push the stock through with a push stick.
- Make all rip fence adjustments after the saw has been turned off and the blade is no longer spinning. Be certain the rip fence is clamped securely while cutting.
- When crosscutting with the miter gauge, never use the fence as a stop unless a clearance block is used. A clearance block prevents the wood from becoming trapped between the fence and the blade.

KICKBACK HAZARD

Kickback occurs when a spinning blade encounters something that stops it while the saw is under full power. On a table saw, the workpiece is kicked back at the operator.

SITUATIONS LEADING TO KICKBACK

- The saw may be twisted to the side during the cut or pulled backwards. This causes the blade to bind.
- The material on one or both sides of the cut bends, pinching the saw blade.
- The rip fence is not parallel to the blade, causing the blade to bind.
- An offcut (waste piece) becomes wedged between the blade and the rip fence when crosscutting.

To avoid kickback:

- Be sure that one edge of the workpiece is always held firmly against the rip fence when ripping. Keep a firm grip on the stock, hold it flat against the table, and push the stock past the blade to complete the cut. Use a push stick when necessary.
- Always support the wood in a way that prevents the cut pieces from pressing against the blade. This might require a table or roller stands placed under the stock where it leaves the table.
- Always work with a sharp blade. Dull blades are more likely to bind or stall.
- When using the miter gauge to crosscut stock, remove the fence or push it well clear of the cutting area to avoid trapping offcuts.

Radial-Arm Saws

For additional information, refer to OSHA regulation 1926.304.

A radial-arm saw is a circular-saw assembly suspended from a movable track in a horizontal arm. Cuts are made by pulling the saw toward you. Be sure to hold the saw securely before turning it on and while cutting to prevent it from lurching forward.

SAFETY PREPARATIONS

- Dress appropriately. Don't wear loose clothing or jewelry that could get caught in the saw blade. Tie long hair back.
- Wear appropriate eye and hearing protection.
- Make sure the teeth of the blade are sharpened correctly.
- Plan to use a respirator if you will be cutting materials that create harmful dust, such as fiber-cement. If possible, connect a vacuum attachment as well.
- Check the manufacturer's manual for any special safety instructions.

SAFE PRACTICES

- Use the correct blade for the work to be done.
- Always keep the safety guard and the anti-kickback device in position unless you are changing the blade.
- Before crosscutting, adjust the anti-kickback device (anti-kickback fingers) to clear the top of the work by about 1/8".
- Make sure the clamps and locking handles are tight.
- Because the saw tends to feed itself into the material, always regulate the rate of cutting by keeping a firm grip on the workpiece.
- Never place your hand closer than 6" to the blade.
- Use a brush or stick to keep the table clear of all scraps and sawdust.
- When finished with a cut, return the saw head all of the way back past the fence.

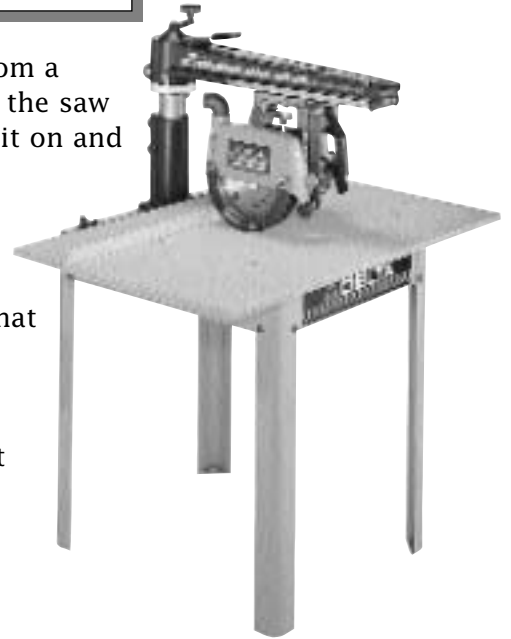

NOTES

Miter Saws

NOTES

For additional information, refer to OSHA regulation 1926.304.

Power miter saws are used to make angled cuts across the grain of wood (crosscuts). There are three types: conventional miter saw, compound-miter saw, and sliding compound-miter saw. With all three, the direction of the cut is away from the operator.

SAFETY PREPARATIONS

- Dress appropriately. Don't wear loose clothing or jewelry that could get caught in the saw blade. Tie back long hair.
- Wear appropriate eye and hearing protection.
- Make sure the teeth of the blade are sharp.
- Check the manufacturer's manual for any special safety instructions.

SAFE PRACTICES

- *Make sure* the saw is equipped with a blade brake. This allows the blade to be stopped quickly after the cut is made.
- Do not disable the blade guard.
- Use the correct cutting motion for the type of miter saw you are using.
- Make sure the stock is held firmly against the fence.
- Support the stock along its entire length. Never cut stock that is too short to hold securely.
- Do not lift stock into the blade.
- Make adjustments to the saw only after the blade has stopped moving.
- Unplug the saw before changing blades.

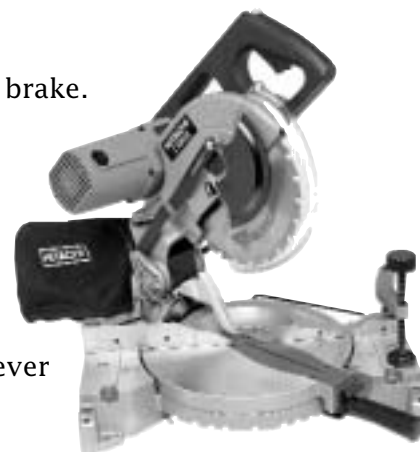

Compound-miter Saw



Sliding
Compound-miter Saw

Jigsaws and Reciprocating Saws

For additional information, refer to OSHA regulation 1926.304.

NOTES

A jigsaw (or saber saw) has a straight, narrow blade that moves rapidly up and down. The reciprocating saw operates similarly but has a longer, more streamlined housing and longer, wider blades. The same safety rules apply to all.

SAFETY PREPARATIONS

- Dress appropriately. Don't wear loose clothing or jewelry that could get caught in the saw blade. Tie back long hair.
- Wear appropriate eye and hearing protection.
- Make sure the blade is sharp.
- Check the manufacturer's manual for any special safety instructions.

SAFE PRACTICES

- Select the correct blade for the work and properly secure it in the saw.
- Be certain the material to be sawed is properly clamped.
- Before starting a cut, look under the workpiece to make sure there are no wires or other obstructions near the line of cut.
- Keep the cutting pressure constant, but if you meet resistance, do not force the cut.
- Hold the saw's baseplate firmly against the workpiece when cutting.
- When finished, turn off the power switch and allow the saw to come to a stop before pulling the blade from the cut and setting the saw down.



Routers

For additional information, refer to OSHA regulation 1926.300.

The router is a portable tool used to shape surfaces and edges and to cut joints. Because it has a sharp rotating bit, the tool must be used with care.

SAFETY PREPARATIONS

- Dress appropriately. Don't wear loose clothing or jewelry that could get caught in the tool. Tie back long hair.
- Wear appropriate eye and hearing protection.
- Wear a dust mask.
- Make certain the fence or guide is securely clamped.
- Make certain the workpiece is securely clamped.
- Check the manufacturer's manual for any special safety instructions.

SAFE PRACTICES

- Make certain the tool's switch is in the "off" position before plugging in the power cord.
- Hold on to the router when turning it on.
- When using the router, keep a firm grip, using both hands when appropriate.
- Make adjustments only when the bit is at a dead stop. When installing or removing bits, be sure the router is unplugged.
- Feed in the correct direction.
- When putting the router down, point the bit away from you. Be aware of a bit that is still moving.
- When using large bits, remove the stock with two or more passes.
- Never use a dull or damaged bit.
- Bring the router to full speed before cutting. Turn off the router after making the cut.

NOTES

Sanders

NOTES

For additional information, refer to OSHA regulation 1926.300.

A power sander automates the tedious task of sanding a surface. Common types of power sanders are the belt sander, the disc sander, and the random-orbit sander. Sanders produce many fine particles that can be harmful if inhaled or if they get in eyes.

SAFETY PREPARATIONS

- Dress appropriately. Don't wear loose clothing or jewelry that could get caught in the tool. Tie back long hair.
- Wear eye and hearing protection.
- Wear a dust mask or respirator when using sanding equipment. If the sander has a dust bag, make sure it is securely attached.
- Make sure the sander's abrasive belt, disc, or pad is in good condition and that its grit is appropriate for the work to be done.
- Check that there are no nicks or tears in the edge of a disc or belt.
- Check the manufacturer's manual for any special safety instructions.

SAFE PRACTICES

- Take care to install an abrasive belt with the correct tension. Be sure it is tracking (aligned on the rollers) properly.
- Make certain the tool's switch is in the "off" position before plugging in the power cord.
- Never touch a sanding belt or disc while it is moving.
- Avoid nails and screws when sanding.
- Disconnect the power cord when changing abrasives.
- When powering down, do not let go of the handles until the belt stops turning.
- Do not use a sander to remove paint containing lead, which is toxic.

Jointers

For additional information, refer to OSHA regulation 1926.302.

A jointer enables an operator to smooth and square off stock, as well as to make rabbets and other kinds of cuts. The cutterhead, the cutting part of the tool, is shielded by a guard, which swings out of the way during use. Accidental cuts and occasional kickback are the chief hazards.

SAFETY PREPARATIONS

- Dress appropriately. Don't wear loose clothing or jewelry that could get caught in the tool. Tie back long hair.
- Wear eye and hearing protection.
- Secure a portable jointer to a structure's subfloor or to a sturdy workbench or other work surface to prevent its tipping over during use.
- Keep the knives of the jointer sharp. Dull knives tend to cause kickback. They also produce a poor cut.
- Check stock for knots, splits, and other imperfections before jointing. Defective stock may break up or be thrown from the jointer.
- Do not joint overly short pieces of wood.
- Check the manufacturer's manual for any special safety instructions.

SAFE PRACTICES

- Make sure that the guard is in place and operating easily.
- Always allow the machine to come to full speed before using it.
- Cut with the grain. Always use a push stick to move stock past the cutterhead. Do not make cuts too deep.
- Never adjust the fence or the depth of cut while the jointer is running.
- Use a brush to remove shavings from the table. Never use your hand.
- Because of the danger of kickback, always stand to the side of the jointer, never directly behind it.



NOTES

Electric Planers and Planes

NOTES

For additional information, refer to OSHA regulations 1926.302 and 1926.304.

Types of electric planes are the stationary planer, the portable planer (sometimes used on construction sites), and the hand-held portable electric plane. Cuts and—in the case of large machines, kick-back—are the chief hazards.

SAFETY PREPARATIONS

- Dress appropriately. Don't wear loose clothing or jewelry. Tie back long hair.
- Wear appropriate eye and hearing protection.
- Make sure all blades are sharp. Dull blades result in a poor cut that can be difficult to control.
- Check the manufacturer's manual for any special safety instructions.

PLANER AND PORTABLE PLANER

- Check each board for loose or large knots, warped surfaces, and other flaws that might cause a problem.
- Never run used lumber through the planer. Nails or other objects in the lumber can be thrown out with great force by the blades.
- Make sure the planer will engage the board with both its infeed and outfeed rollers. Check that the board is several inches longer than the distance between rollers.
- Because of the danger of kickback, stand to the side of the planer, never directly behind it. Never look into the planer when it is running.
- Do not force stock; let the infeed roller pull it through. Do not pull stock out of the planer. As the stock exits, support it on your fingertips or on an outfeed table.
- Take a series of shallow cuts rather than one deep cut. A too-deep cut can overload the planer.

PORTABLE ELECTRIC PLANE

- Clamp small pieces to prevent movement or vibrations.
- Use two hands to guide the plane. Stand so you can guide the tool with an uninterrupted cutting motion.
- Do not put the tool down until the motor has stopped.
- Disconnect the cord from the power source before making adjustments.

Plate Joiners

For additional information, refer to OSHA regulation 1926.302.

NOTES

A plate joiner is a portable power tool that cuts crescent-shaped grooves in the edge of wood stock. Pieces with matching cuts can then be joined by means of a plate, or biscuit, inserted and glued into the matching grooves. Hazards include kickback and flying chips.

SAFETY PREPARATIONS

- Dress appropriately. Don't wear loose clothing or jewelry that could get caught in the tool. Tie back long hair.
- Wear appropriate eye and hearing protection.
- Keep the blades of the plate joiner sharp. Dull blades tend to cause kickback. They also produce a poor cut.
- Check the operation of the guard before using the tool. It should close smoothly over the blade.
- Clamp any workpiece that is likely to move during the cut.
- Check the manufacturer's manual for any special safety instructions.

SAFE PRACTICES

- Even with eye protection, keep your face away from the dust ejection chute. A plate joiner ejects dust and chips at a high rate of speed.
- Do not disable the anti-kickback points on the faceplate. Make sure the points engage the workpiece.
- Keep hands away from the blade area when making cuts.
- Never hold a workpiece in your hand while cutting.
- Retract the blade fully after a cut. Failure to retract the blade may allow it to contact the workpiece too soon during the next cut. This can cause kickback.
- Unplug the power cord when changing blades or performing routine maintenance.

Lasers

NOTES

For additional information, refer to OSHA regulations 1926.54 and 1926.102.

Lasers are used in a number of construction applications where reference to level is required, such as surveying a site. Generally, laser levels used for distance work outdoors produce an infrared laser beam. Visible-beam lasers are more often used in interior work.

Construction lasers typically produce low-power diode-generated beams. Most visible-beam lasers are Class II, limited to less than 5 milliwatts (mW) output. Infrared lasers are designated Class I, with lower wattage still.

SAFETY PREPARATIONS

- Make sure the equipment is in good working order.
- Check the manufacturer's manual for any special safety instructions.
- To determine eye protection needs, check the output rating of the laser as follows:

Eye Protection Needs

If the rating is 5 mW or less...

- ♦ No eye protection is required. Most laser levels are rated at under 5 mW.

If the rating is greater than 5 mW...

- ♦ Wear laser safety goggles appropriate to the wavelength of the laser.

SAFE PRACTICES

- Never direct the laser beam at any person. Do not look head-on into the beam.
- Never set a visible-beam laser in the open where it might strike a worker or passer-by in the eye.

Power Nailers and Staplers

For additional information, refer to OSHA regulation 1926.302. See also Technical Links on the OSHA website.

NOTES

Power nailers (air nailers) and staplers use great force to drive fasteners (nails or staples) into wood or other material. A *pneumatic tool* uses pressure supplied from an air compressor through an attached hose. A *cordless tool* is self-contained. It runs on an internal combustion engine and compressed gas.

SAFETY PREPARATIONS

- Dress appropriately. Don't wear loose clothing or jewelry that could get caught in the tool. Tie back long hair.
- Wear appropriate eye and hearing protection.
- Keep bystanders away from the work area.
- Check the manufacturer's manual for any special safety instructions.

SAFE PRACTICES

- Never fire the nailer or stapler until the nosepiece is in contact with the workpiece. Although these tools are designed to fire only when the trigger is pulled *and* the nosepiece makes contact, a misfire could occur.
- Never finger the trigger while carrying a nailer or stapler. The tool could fire accidentally if it comes into contact with a person or object.
- Never attempt to override the safety mechanism.
- Never try to clear a jammed tool while it is still connected to an air supply or power source. Disconnect the tool before performing any maintenance on it.

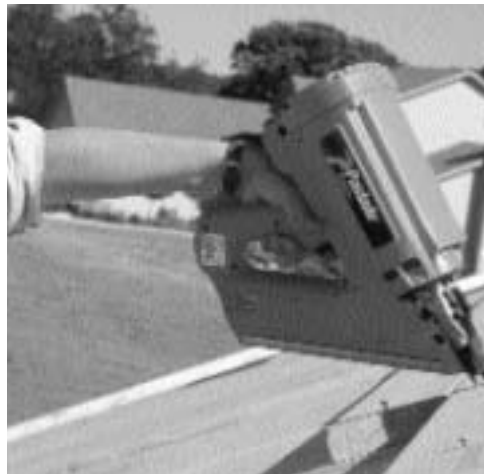

(Continued on next page)

NOTES

PNEUMATIC TOOLS

- Before transporting an air compressor, release the pressure in the air-storage tank. Secure the compressor so it does not roll around in the vehicle.
- If you are using a belt-driven air compressor, make sure the belts are protected by a cover.
- The air hose should have a minimum working-pressure rating that is 50 percent higher than the maximum pressure delivered by the compressor.
- Check the condition of the hose regularly. Never step on the hose, and do not use it to hoist or dangle the tool.
- Make sure the tool is pointed at the ground when you connect a pressurized air hose to it. The sudden entrance of pressurized air could cause the tool to fire. Check the connection to make sure it is secure.
- Do not operate the tool at a higher pressure than it was designed for. Pressure of the compressed air is indicated in pounds per square inch (psi) on the pressure gauge of the air compressor. Check the gauge periodically.
- Pay particular attention to the hose while using a pneumatic tool on a roof. A hose is easy to trip over. It can also sweep tools off the roof. Secure the hose to a point near the place where you are working.
- Never use bottled gas to power a nailer or stapler. A spark could cause an explosion.
- Never point a pneumatic tool at anyone.

Welding Tools and Equipment

For additional information, refer to OSHA regulations 1910.252-1910.254 and 1926.350-1926.354.

NOTES

Two common welding methods are gas welding and arc welding. In gas welding, the operator uses a torch with an intense flame, usually fed by oxygen and acetylene gas, to melt the metal and achieve a weld. In *arc welding*, the operator uses an electrode to produce an arc that heats the metals to achieve a weld. Welding must be done carefully. Burns, fires, dangerous fumes, and ultraviolet radiation are among the hazards.

PREPARATIONS AND PRACTICES

- Dress appropriately. Don't wear anything that could come into contact with a flame, arc, or hot metal. Tie back long hair.
- Wear appropriate eye, face, hand, and breathing protection.
- Check the manufacturer's manual for any special safety instructions for the equipment you are using.
- Provide appropriate ventilation. In confined areas, use an exhaust ventilator. Never ventilate with oxygen. Adequate ventilation is especially important when welding materials that produce toxic fumes.
- Some preservative coatings are flammable. If necessary, conduct a flammability test with a small sample of scrapings. If a coating is highly flammable, it must be stripped from the surface before welding begins.
- Always keep a fire extinguisher at hand.

GAS WELDING AND CUTTING

- Wear a welder's mask or goggles with appropriate lens and other protection as needed.
- Make sure the work area is free of flammable materials such as paints, solvents, dust, grease, or other materials.
- Inspect all hoses carrying acetylene, oxygen, or any other volatile gases before starting work, or verify that such an inspection has taken place.
- Immediately report any defect in a fuel gas cylinder or hoses to the supervisor.

(Continued on next page)

NOTES

- Keep compressed gas cylinders at a safe distance to avoid sparks, hot slag, or flame. Otherwise, use fire-resistant shields.
- Open the cylinder valve slowly. Open an acetylene cylinder valve about three-fourths turn of the spindle but no more than one and one-half turns (see OSHA regulation 1910.253).
- Do not touch any part of the torch except the grip end. Do not touch any metal near the weld. The metal may have heated up some distance from the weld itself.
- Shut off the torch valves and the fuel-gas and oxygen supply to the torch when suspending work.

ARC WELDING AND CUTTING

- Wear a welding helmet and hand shields to protect face and hands from ultraviolet (UV) radiation from the arc.
- Use only equipment that is appropriate for the job and in good condition. Use only manual electrode holders specifically designed for welding and cutting. Make sure the holders are capable of safely handling the maximum rated current required by the electrodes.
- Make sure the cables are in good condition and that the insulation has not been worn away.
- Report any faulty or defective equipment to the supervisor immediately.
- Shut off power to the equipment if you leave the immediate work area.
- Do not dip hot electrode holders in water; doing so may cause electric shock.
- When not in use, remove the electrodes from the holders. Put the holders away in a safe place.



Materials Handling

| | |
|--|-----|
| One Wrong Move | 104 |
| 6-1 Storing Nonhazardous Materials | 105 |
| 6-2 Waste Disposal | 106 |
| 6-3 Hazardous Materials | 107 |
| 6-4 Bulk Lifting/Moving Operations..... | 109 |



One Wrong Move

Two laborers and a forklift driver were stacking 40' I-beams in preparation for structural steel framing. One laborer was placing a 2×4 wooden spacer on the top I-beam on the stack. The forklift driver drove up to the stack with another I-beam that was not secured or blocked on the forklift tines. The I-beam fell from the tines, pinning the laborer between the fallen I-beam and the stack of beams. He was fatally injured.

- The forklift operator was not wearing a seat belt.
- There was no safety monitor on the site.
- No safety and health program was in effect.
- The worksite was not inspected regularly.
- No training and education were provided.

Everyone on the worksite must learn to recognize and avoid unsafe conditions. Loads on forklifts and other powered industrial trucks should be stable and secure. People should maintain proper distance from the elevated portions. Appropriate personal protective equipment should be worn.

Work carefully and safely.

Accidents such as this one could be avoided by following OSHA regulations 1926.20 (safety program and inspections), 1926.21 (safety training and education), 1926.28 (personal protective equipment), and 1926.602 (material handling equipment).

Storing Nonhazardous* Materials

For additional information, refer to OSHA regulation 1926.250.

NOTES

Weight and stability are the most important factors to consider when storing construction materials. Care must be taken when lifting and stacking to avoid injury and accidents.

GENERAL STORAGE GUIDELINES

- Keep storage areas free of scraps and debris. Keep flammable materials away from lumber or other combustible materials.
- When lifting loads, use your legs, not your back. Bend your knees while keeping your back straight. Use lifting equipment for heavy loads.
- Stack materials at least 6' away from floor openings.
- For floors that are not on grade, check the posted maximum safe load before stacking materials.
- Stack materials only on level surfaces.
- Stack bagged materials by stepping back the layers and cross-keying the bags at least every 10 bags high.
- Store structural steel pipes, poles, or other cylindrical materials by racking. Otherwise, stack and block them to prevent spreading or tilting.

LUMBER

- If lumber is to be handled manually, stack no higher than 16'. Otherwise, stack it no higher than 20'.
- Remove all nails from used lumber before stacking it.

BRICKS AND BLOCKS

- Stack bricks no higher than 7'. At 4' taper the stack back 2" and then taper 2" back at 5' and again at 6'.
- When stacking masonry blocks, taper the stack back one-half block per tier above the 6' level.

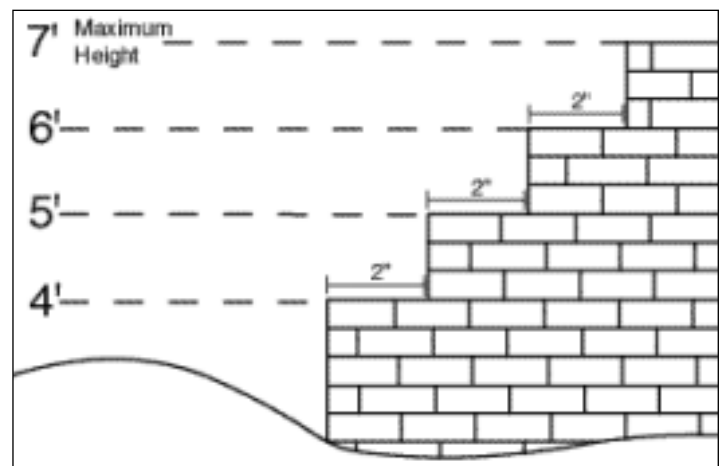

*Hazardous materials are discussed in Safety Sheet 6-3.



Waste Disposal

NOTES

For additional information, refer to OSHA regulation 1926.252.

Materials labeled *hazardous* are in and of themselves harmful. Information about handling hazardous materials is provided in Safety Sheet 6-3. However, even nonhazardous waste material can create hazards on a construction site when not disposed of promptly and properly. Follow these guidelines to minimize the danger.

DISPOSING OF WASTE

- Remove all scrap lumber and other debris from the immediate work area as the work progresses.
- Keep solvent waste, oily rags, and flammable liquids in fire-resistant, covered containers until removed from the worksite.
- If you incinerate trash, make sure you are complying with local fire regulations.
- When dropping debris from a height of more than 20' to any point outside the exterior walls of the building, use an enclosed chute.
- When dropping debris through holes in the floor without using chutes, post signs at each level warning of the hazard of falling material. The area into which the debris is dropped must be surrounded by a barricade at least 42" high and at least 6' back from the edge of the opening above.

Hazardous Materials

For additional information, refer to OSHA regulations 1910.120, 1910.1048, 1926.55, 1926.57, 1926.62, 1926.1100-1926.1152.

NOTES

On a construction site, hazardous materials must be stored and disposed of appropriately. The following table summarizes some hazardous substances encountered in construction work and the effects they can have on health.

| Materials and Health | | |
|--|--|--|
| Substance | Found in... | Potential Health Effects |
| Asbestos | Old building materials encountered in rehab jobs, including insulation, roofing shingles, etc. | Chronic lung disease (asbestosis), increased risk of several kinds of cancer |
| Crystalline silica | Dust from sawing of rock, concrete, or masonry | Silicosis, a life-threatening lung disease |
| Lead | Old building materials, including solders, fluxes, paints | Serious damage to nervous system, blood-producing organs, liver, reproductive system |
| Formaldehyde | Resins used in construction materials and adhesives | Increased risk of cancer |
| Organic solvents (turpentine, petroleum distillates, benzene, toluene, etc.) | Paint thinner, varnishes, lacquers | Dermatitis (a skin condition), increased risk of cancer, damage to nervous system, reproductive system, liver, kidneys |
| Benzofluoranthene, thiram, o-Dichlorobenzene, chromium II | Wood preservatives | Irritation to eyes, skin, mucous membranes; damage to nervous system (thiram; asthma (chromium II)) |
| Fiberglass | Insulation | Possible increased risk of lung cancer |

(Continued on next page)

NOTES

HANDLING HAZARDOUS MATERIALS

Construction workers who handle hazardous substances must receive training.* Workers must avoid ingesting (swallowing or breathing in) these substances and, in some cases, avoid skin contact as well. In general, follow these guidelines when working with hazardous materials:

- Wear appropriate eye and breathing protection.
- Avoid skin contact with hazardous substances such as *solvents* and *formaldehyde*. Use nonlatex gloves such as butyl rubber or Teflon. Many people are allergic to latex, which is required only when infection is a hazard, such as in hospitals and medical labs.
- Use *solvents* such as varnish and paint thinner only in well-ventilated spaces. Avoid prolonged exposure.
- Store highly *flammable materials* in nonflammable closed containers, away from heat sources.
- Use a NIOSH-certified respirator when working with any airborne hazard, such as *lead* dust (removing old paint), *crystalline silica* particulates (sawing masonry or brick), or *fiberglass* (blowing insulation into attic or walls). Your construction supervisor must provide respirators that conform to OSHA regulations.
- Use water spray when sawing masonry, brick, or rock, to reduce the hazard of airborne *crystalline silica*.
- Do not work around hazardous materials for which you are not trained. *Asbestos* can be removed only by professionals specially trained for asbestos mitigation work. In many states, *lead* removal requires licensed lead-abatement contractors.
- Wash thoroughly at the end of work. Change clothes if you have been exposed to toxic airborne particles, such as *lead* dust.

PROTECT FAMILY MEMBERS, TOO

OSHA has set a permissible exposure limit (PEL) for workers exposed to lead. However, a study published in 1997 revealed that children of construction workers had a higher risk of lead poisoning than other children. Apparently, construction workers were bringing home lead dust on their work clothes.

If you are being exposed at work to lead dust or other toxic particulates, follow these guidelines to ensure the safety of the people at your home:

- Use work clothes that are distinct from street clothes.
- Change out of the work clothes and shower after work.
- Handle, sort, and wash work clothes separately from other clothes.

*See Safety Sheet 3-4 for what you need to know about hazardous materials on the worksite.

Bulk Lifting/Moving Operations

For additional information, refer to OSHA regulations 1910.178 (forklift), 1926.251 (rigging), and series 1926.550-556 (cranes, hoists, derricks, and conveyors).

NOTES

On any construction site, heavy objects or stacks of materials must be lifted or moved laterally. Common lifting devices include forklifts, cranes, derricks, and hoists. Lateral movement can be accomplished by conveyors, forklifts, cranes, and other means. Lifting and moving operations require *competent* (trained) personnel to operate the appropriate equipment. Lifting often involves *rigging*, the use of rope, synthetic, or wire slings. Workers who perform rigging tasks also need *special training*.

Moving heavy loads creates a potential for accidental injury. When working on a construction site, pay careful attention to lifting and moving operations.

SAFETY AROUND FORKLIFTS

Forklifts pose special hazards in that they must ply passages, often narrow, in construction sites without harming people at work on the site. Furthermore, these vehicles may become destabilized in proportion to the weight and distance of an extended load. *Special training* is required to operate a forklift safely.

Like other vehicles, a forklift may pose emissions hazards or other hazards related to power generation. Fueling cautions similar to those for other vehicles apply, except extra care must be taken in the confined spaces of a construction site.

Follow these guidelines when working around forklifts.

- Never operate a forklift unless you are *trained* to do so.
- Never walk under the raised pallet of a forklift, whether loaded or not.
- Keep a safe distance from a loaded pallet that is being raised or otherwise moved.
- Never walk into or across the path of a moving forklift.
- Never accept a ride on a forklift. The vehicle is designed to carry only the operator and load.
- Never participate in horseplay involving a forklift. Deaths and serious injuries have resulted from improper operation and use of these vehicles.

(Continued on next page)

NOTES

- Be alert for posted signs indicating travel lanes for forklifts.
- Be alert for horns or other audible signals indicating the approach of a forklift. If you hear such a signal, clear traffic lanes.
- Be aware of your surroundings and make others aware of your presence.
- Do your part to keep the construction site, especially passageways and traffic lanes, free of debris.
- Stay away from fueling or battery-charging areas of the construction site.

CRANES, HOISTS, DERRICKS

Only *competent* personnel are qualified to operate a crane, hoist, or derrick. In general, follow these guidelines:

- Federal regulations require a barricade to shield the swing radius of the rear of the rotating structure of a crane. Never attempt to cross this barricade.
- Never enter an area in which a crane or hoist is operating without wearing a hardhat.
- When traveling on a lifting device such as a hoist or elevator, always keep all parts of the body inside the edges of the platform.
- When traveling on a personnel platform hoisted by a crane, wear a body belt or body harness system with a lanyard—unless you are over water. Keep in view of or in direct communication with the crane operator or signal person.
- Heed any posted warnings, such as “No Riders Allowed,” which might appear near a materials hoist.

SAFETY AROUND CONVEYORS

Only *competent* personnel are qualified to operate a conveyor. *Training* is required to load or unload materials from a conveyor. In general, follow these guidelines:

- Keep away from loading and unloading points on the conveyor unless you are involved in these activities.
- Pay attention to signs marking crossover points of the conveyor.

Glossary

American National Standards Institute (ANSI)—Agency that sets standards for safety, such as requirements for tools and equipment.

asbestos—Mineral fiber, formerly used in roofing and insulating materials, implicated as the cause of several kinds of cancer.

asbestosis—Chronic lung disease resulting from exposure to asbestos.

authorized person—OSHA term for a person who is approved or assigned by the employer to perform a specific type of duty or to be at a specific location. (Also, *designated person*.)

barricades—Barriers placed around areas where hazardous work or conditions are present.

benching—Cave-in prevention technique in which the sides of an excavation are cut into steps.

bursitis—Inflammation of sacs that cushion joints.

cardiopulmonary resuscitation (CPR)—Procedure designed to help an accident victim breathe and to restart the heart. Must be done *only* by persons trained by qualified professionals.

carpal tunnel syndrome (CTS)—A common repetitive stress injury (RSI) affecting the wrist and hand.

cave-in—Collapse of an excavation wall.

closed container—Defined by OSHA as a container sealed with a lid or other device so that neither liquid nor vapor can escape at ordinary temperatures.

competent person—OSHA term for a person capable of identifying existing and predictable hazards and authorized to correct or eliminate these problems.

confined space—Described by OSHA as a space large enough to work in, subject to the accumulation of toxic or flammable contaminants or oxygen deficiency, with limited means of entry or exit. Also called *enclosed space*.

designated person—OSHA term for a person who is approved or assigned by the employer to perform a specific type of duty or to be at a specific location. (Also, *authorized person*.)

dust mask—Simple protective covering over the nose and mouth.

entry permit—Required form, signed by the entry supervisor, that allows a specified worker to enter a confined space.

ergonomics—Science of designing and arranging items to meet the needs of the human body.

flammable—Able to catch fire easily.

ground-fault circuit interrupter (GFCI)—Device that acts as a circuit breaker to protect against electrical shock.

hazard communication (HAZCOM)—Threefold process developed by OSHA that ensures the appropriate information about hazardous substances is provided to employers and employees to protect workers' health.

hazardous materials—Substances that are in and of themselves harmful.

hyperthermia—Heat stress.

hypothermia—Cold stress.

kickback—A sudden violent thrust back and upward that results when a spinning saw blade encounters something that stops it while the saw is under full power.

Glossary (Continued)

lockout/tagout—Required OSHA procedure, performed only by authorized persons, in which all energy sources are turned off or disconnected and energy-isolating devices are locked out and/or labeled with a warning tag.

material safety data sheet (MSDS)—Required information sheet that explains any hazards associated with a substance.

maximum intended load—Rating system for ladders and scaffolds related to the amount of weight they can safely support.

musculoskeletal disorder (MSD)—A problem with muscles, tendons, ligaments, joints, cartilage, or spinal discs.

National Fire Protection Association (NFPA)—International organization that sets codes and standards for fire safety.

National Institute for Occupational Safety and Health (NIOSH)—Federal agency that identifies causes of occupational injuries and illnesses and provides training to prevent them.

nonpermit-required confined space—OSHA designation of a space with limited access that does not contain, and does not have the potential to contain, any hazard that could cause serious injury or death.

Occupational Safety and Health Administration (OSHA)—Federal agency that sets and enforces standards for safety in the workplace.

pathogen—Disease-causing agent, such as a virus.

permissible exposure limit (PEL)—Rating set by OSHA as the maximum limit of worker exposure to hazardous materials such as lead.

permit-required confined space—OSHA designation of a confined space that contains, or potentially contains, serious safety or health hazards.

pounds per square inch (psi)—Unit used to measure the pressure of compressed air in an air compressor.

qualified person—OSHA term for a person with a degree, certificate, or professional standing or extensive knowledge, training, and experience. The person has demonstrated the ability to solve or resolve problems relating to the project.

repetitive stress injury (RSI)—Irritation to nerves and tissues at or near joints that results from doing the same physical task repeatedly.

respirator—A facepiece, hood, or helmet designed to protect against harmful airborne agents.

silicosis—A life-threatening lung disease resulting from inhaling too much dust from the sawing of rock, concrete, or masonry.

slide guard—A 2×6 set with roof brackets at a 90° angle along the run of the roof.

slope—Gentle angle at which soil is piled in an excavation as a precaution against cave-ins.

tagout—Placing a warning tag on a safety hazard, such as a defective tool. See also *lockout/tagout*.

ultraviolet (UV) radiation—The part of sunlight that can be harmful to skin and eyes, especially if exposure is prolonged or frequent.